

User Manual X6

Document Version: 1.1
Release Date: 2015/6/9

Table of Content

Figures	5
Tables	7
1 Safety Instruction	8
2 Overview	9
3 Installation	10
3.1 Use PoE or external Power Adapter	10
3.2 Desktop and Wall-mount Installation.....	11
4 Introduction to the Phone User Interface	13
4.1 Keypad	13
4.2 Using Handset / Hands-free Speaker / Headphone	14
4.3 Screen User Interface	15
4.4 Web Portal.....	16
5 Setting Up	19
5.1 Network Configuration.....	19
5.2 Line Configurations.....	20
6 Using the Phone	23
6.1 Making Phone Calls	23
6.1.1 Make / Receive Second Call	27
6.1.2 Join / Split Two Calls (3-way Local Conference).....	28
6.1.3 Call Transfer	29
6.2 Using Phonebook	29
6.2.1 Add / Edit / Delete Contact	31
6.2.2 Add / Edit / Delete Group	31
6.2.3 Browse and Add / Remove Contacts in Group	32
6.3 Using Cloud Phonebook.....	33
6.3.1 Open Cloud Phonebook	34
6.4 Call Logs	35
6.5 Voice Message	36
6.6 Do-Not-Disturb	37
6.7 Auto-Answering	39
6.8 Call Forward.....	40

6.9 DSS LCD Configuration	43
7 Phone Settings	45
7.1 Adjust Audio Volume	45
7.2 Set Ring Tone Volume and Type	45
7.3 Adjust LCD Contrast.....	45
7.4 Set Device Time/Date	46
7.5 Set Device Language.....	47
7.6 Bluetooth Headset	47
7.7 Reboot the Device	47
7.8 Reset to Factory Default.....	48
8 Web Portal.....	49
8.1 Web Portal Authentication	49
8.2 SYSTEM / Information	49
8.3 SYSTEM / Account.....	49
8.4 SYSTEM / Configurations	50
8.5 SYSTEM / Upgrade	50
8.6 SYSTEM / Auto Provision.....	50
8.7 SYSTEM / Tools	51
8.8 NETWORK / Basic	51
8.9 NETWORK / Service Port	51
8.10 NETWORK / Advanced.....	51
8.11 NETWORK / VPN.....	52
8.12 LINES / SIP	52
8.13 LINES / Dial Plan	57
8.14 LINES / Register Settings	60
8.15 PHONE / Features.....	60
8.16 PHONE / Audio	64
8.17 PHONE / MCAST.....	65
8.18 PHONE / Action Url	65
8.19 PHONE / Time/Date	66
8.20 PHONE / Advanced	67
8.21 PHONEBOOK / Contacts	67
8.22 PHONEBOOK / Cloud Phonebook	68
8.23 PHONEBOOK / Blacklist.....	69

8.24 PHONEBOOK / Advanced.....	69
8.25 CALL LOGS.....	69
8.26 FUNCTION KEY / Function Key	70
8.27 FUNCTION KEY / Advanced.....	71
8.28 Security / Security.....	71
8.29 Device Log/ Device Log.....	71
9 Advanced Features.....	72
9.1 VPN.....	72
9.1.1 L2TP	72
9.1.2 OpenVPN.....	73
10 Trouble Shooting	74
10.1 Get Device System Information.....	74
10.2 Reboot Device.....	74
10.3 Reset Device to Factory Default	74
10.4 Network Packets Capture	75
10.5 Common Trouble Cases	75
Appendix I - Icon Illustration.....	77
Appendix II – Text Input from Keypad	79
Appendix III – LED Definition	81

Figures

Figure 1 - Desktop Installation	11
Figure 2 - Change handset hook to wall-mount mode	11
Figure 3 - Wall-mount Installation	12
Figure 4 - Connecting to the Device.....	12
Figure 5 - Keypad.....	13
Figure 6 - Screen Layout / Default Standby Screen	15
Figure 7 - Vertical Scroll Bar.....	16
Figure 8 - Check the Device's IP Address.....	17
Figure 9 - Web Portal Login Page	18
Figure 10 - SIP address and account information.....	20
Figure 11 - Line proxy information	21
Figure 12 - Configure Advanced Line Options.....	21
Figure 13 - Account Advanced Settings(1).....	22
Figure 14 - Account Advanced Settings(2).....	22
Figure 15 - Account Advanced Settings(3).....	22
Figure 16 - Default Line.....	23
Figure 17 - Dialing a Number before Audio Channel Opened.....	24
Figure 18 - Dial a Number after Audio Channel Opened	24
Figure 19 - Calling Remote Party	25
Figure 20 - Incoming Call Screen	25
Figure 21 - Talking Mode Screen.....	26
Figure 22 - Call Holding Screen.....	26
Figure 23 - Dual Calls.....	28
Figure 24 - Conference Call	28
Figure 25 - Phonebook screen.....	30
Figure 26 - Local Phonebook	30
Figure 27 - Browsing Phonebook	30
Figure 28 - Add New Contact	31
Figure 29 - Group List.....	32
Figure 30 - Browsing Contacts in a Group	32
Figure 31 - Add Contacts in a Group.....	33
Figure 32 - Cloud Phonebook List.....	34

Figure 33	- Downloading Cloud Phonebook	34
Figure 34	- Browsing Contacts in Cloud Phonebook	34
Figure 35	- Call Logs	35
Figure 36	- Filter Call Log Type	36
Figure 37	- New Voice Message Notification	36
Figure 38	- Voice Message Screen	37
Figure 39	- Configure the Voice Message Number	37
Figure 40	- DND Enabled	38
Figure 41	- Configure DND	39
Figure 42	- DND Timer Settings	39
Figure 43	- Configure Auto-answering on Line1	40
Figure 44	- Auto-answering Enabled	40
Figure 45	- Select Line for Call Forward Configuration	41
Figure 46	- Select Call Forward Type	42
Figure 47	- Activate Call Forward and configure Call Forward Number	42
Figure 48	- Set Delay Time for Call Forward on No Answer	42
Figure 49	- DSS LCD Page Configuration Screen	43
Figure 50	- DSS LCD Screen Configuration	44
Figure 51	- Bluetooth Settings Screen	47
Figure 52	- Dial Plan	57

Tables

Table 1 - Time Settings Parameters.....	46
Table 2 - Line Configuration on Web.....	52
Table 3 - Global Settings for Lines on Web.....	60
Table 4 - Common Phone Feature Settings on Web.....	60
Table 5 - Audio Settings on Web.....	64
Table 6 - MCAST Parameters on Web	65
Table 7 - Time/Date Setting Parameters on Web.....	66
Table 8 - DSS Key Setting Parameters on Web.....	70
Table 9 - Trouble Cases.....	75
Table 10 - Keypad Icons.....	77
Table 11 - Status Prompt and Notification Icons.....	77
Table 12 - Look-up Table of Characters.....	79
Table 13 - DSS KEY LED State.....	81
Table 14 - ENB LED State.....	81

1 Safety Instruction

Please read the following safety notices before installing or using this unit. They are crucial for the safe and reliable operation of the device.

- Please use the external power supply that is included in the package. Other power supply may cause damage to the phone, affect the behavior or induce noise.
- Before using the external power supply in the package, please check the home power voltage. Inaccurate power voltage may cause fire and damage.
- Please do not damage the power cord. If power cord or plug is impaired, do not use it, it may cause fire or electric shock.
- Do not drop, knock or shake the phone. Rough handling can break internal circuit boards.
- This phone is design for indoor use. Do not install the device in places where there is direct sunlight. Also do not put the device on carpets or cushions. It may cause fire or breakdown.
- Avoid exposure the phone to high temperature or below 0°C or high humidity.
- Avoid wetting the unit with any liquid.
- Do not attempt to open it. Non-expert handling of the device could damage it. Consult your authorized dealer for help, or else it may cause fire, electric shock and breakdown.
- Do not use harsh chemicals, cleaning solvents, or strong detergents to clean it. Wipe it with a soft cloth that has been slightly dampened in a mild soap and water solution.
- When lightning, do not touch power plug, it may cause an electric shock.
- Do not install this phone in an ill-ventilated place. You are in a situation that could cause bodily injury. Before you work on any equipment, be aware of the hazards involved with electrical circuitry and be familiar with standard practices for preventing accidents.



2 Overview

The new Fanvil X6 IP Phone is a high-end enterprise desktop phone which comes with an intelligent DSS Key-mapping LCD to increase enterprise users' productivity at a cost-effective price.

The DSS Key-mapping LCD is designed with intelligence to support dynamic usage to substitute expansion modules. There are 8 DSS keys corresponded to the LCD display to provide dynamic Line/DSS/BLF functions up to five pages at virtualized total 40 DSS keys. User may configure/customize each DSS key in each page. Every DSS key has a LED indication in green, red, and yellow colors to reflect the key state. There is also one DSS event notification button to notify user whenever there is an event in other page(s). A page shortcut button is also designed to allow user to quickly switch between pages. X6 is the most economic choice for SMB office and enterprise supervisors.

Evolved from Fanvil's C62/C66 enterprise IP phones, X6 pushes its high-end cost-effective enterprise IP phone to another level. X6 inherits all enterprise features from Fanvil's C-Series enterprise phones, such as HD voice in handset, headset, and full-duplex speakerphone modes, PoE, Fast/Gigabit Ethernet, QoS, secure transmission, auto-provisioning, and more.

X6 is a great office productivity appliance for enterprise users. The old DSS key label is inconvenient and not environmental friendly. X6's intelligent DSS Key-mapping LCD provides users the flexibility to change DSS key definition and display through easy configuration. Meanwhile, with its intelligent design of the DSS key/LCD, it can be multiplied as expansion modules to save space and cost. X6 will provide the best user experience to advance enterprise users."

In order to help some users who are interested to read every detail of the product, this user manual is provided as a user's reference guide. Still, the document might not be up to date with the newly release software, so please kindly download updated user manual from Fanvil website, or contact with Fanvil support if you have any question using X6.



3 Installation

3.1 Use PoE or external Power Adapter

X6, called as 'the device' hereafter, supports two power supply modes, power supply from external power adapter or 802.3af Class 2 Power over Ethernet (PoE) complied switch (PoE support also applies to X6G).

PoE power supply saves the space and cost of providing the device additional power outlet. With a PoE switch, the device can be powered through a single Ethernet cable which is also used for data transmission. By attaching UPS system to PoE switch, the device can keep working at power outage just like traditional PSTN telephone which is powered by the telephone line.

For users who do not have PoE equipment, the traditional power adaptor should be used. If the device is connected to a PoE switch and power adapter at the same time, the power adapter will be used in priority and will switch to PoE power supply at power failure on the power adapter.

Please use the power adapter supplied by Fanvil and the PoE switch met the specifications to ensure the device worked properly.



3.2 Desktop and Wall-mount Installation

The device supports two installation mode, desktop and wall-mount. To set up the phone to be used on desktop, please follow the instructions in below picture to install the device.

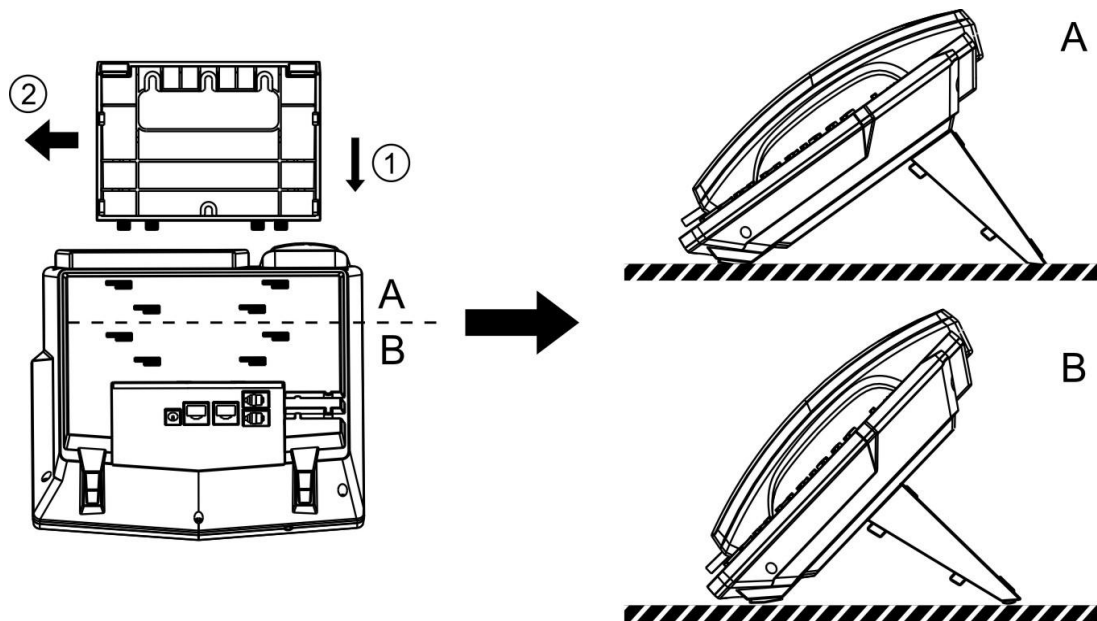

Figure 1 - Desktop Installation

To mount the device on the wall, please follow the instructions in below picture.

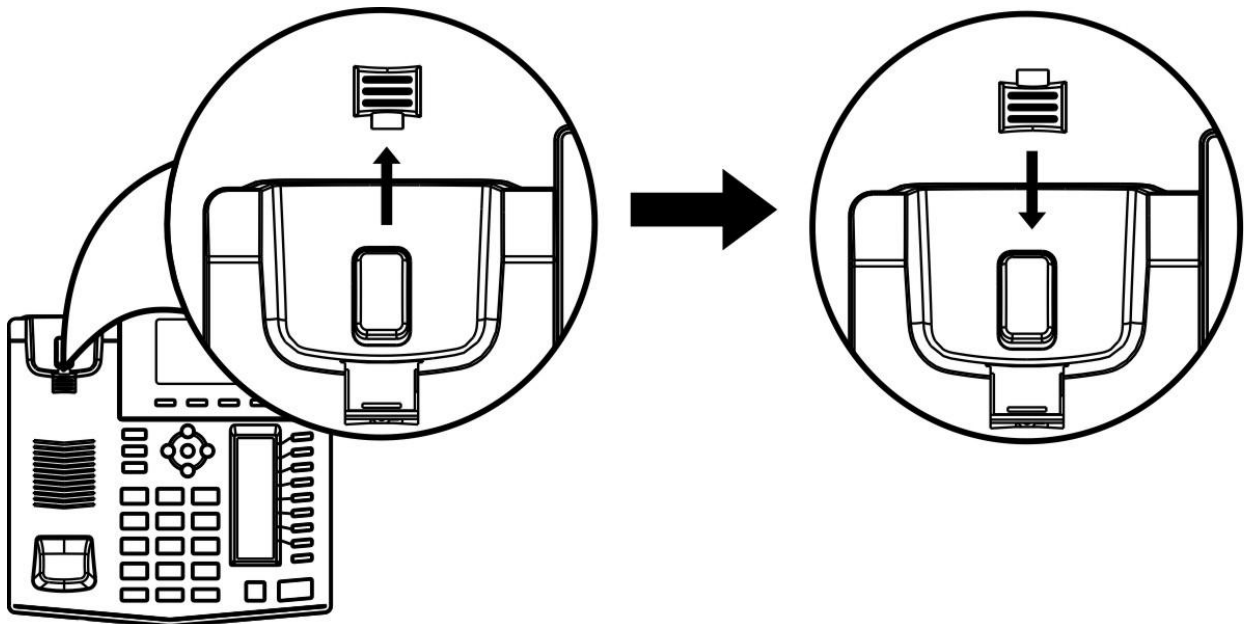

Figure 2 - Change handset hook to wall-mount mode



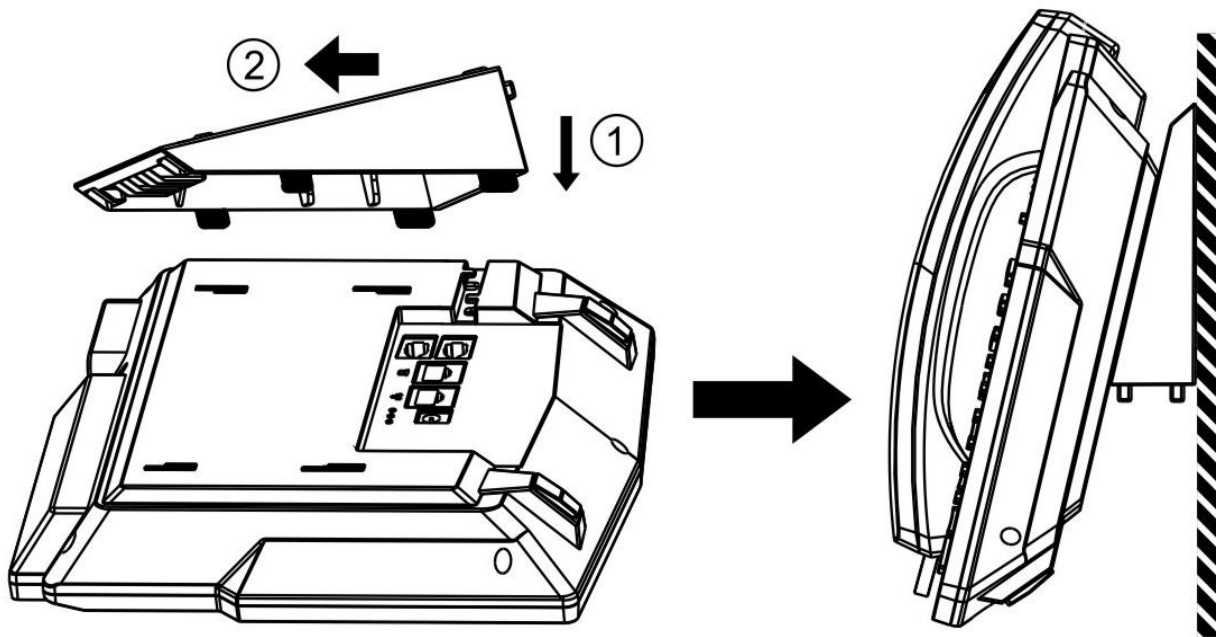

Figure 3 - Wall-mount Installation

Please connect power adapter, network, PC, handset, and headphone to the corresponding ports as described in below picture.

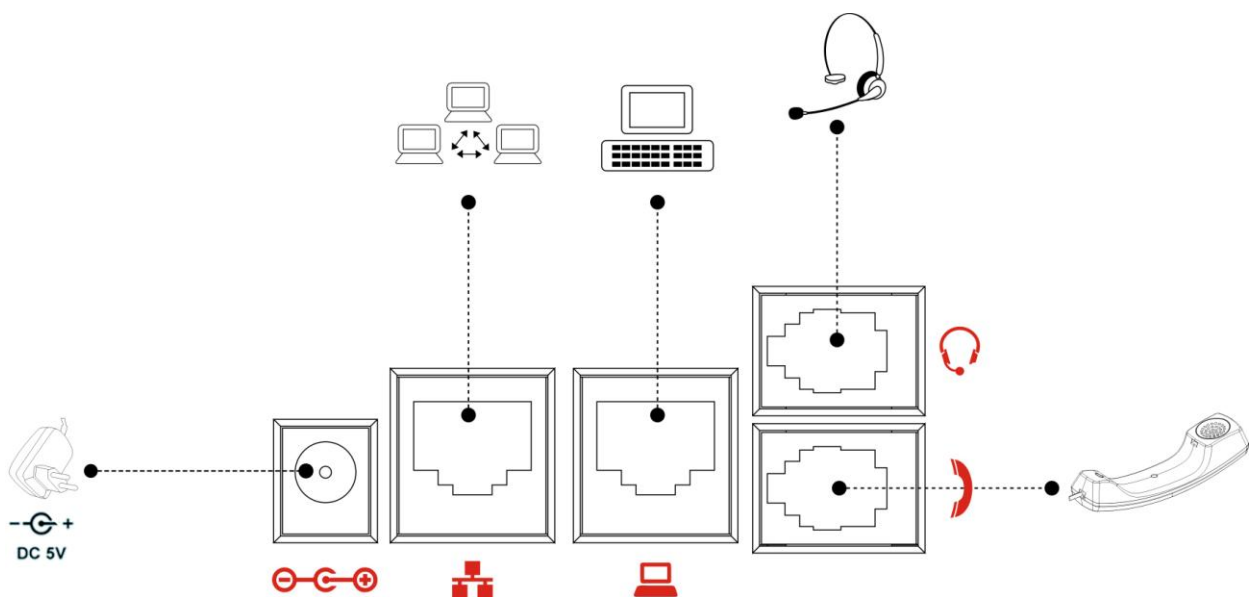

Figure 4 - Connecting to the Device



4 Introduction to the Phone User Interface

4.1 Keypad

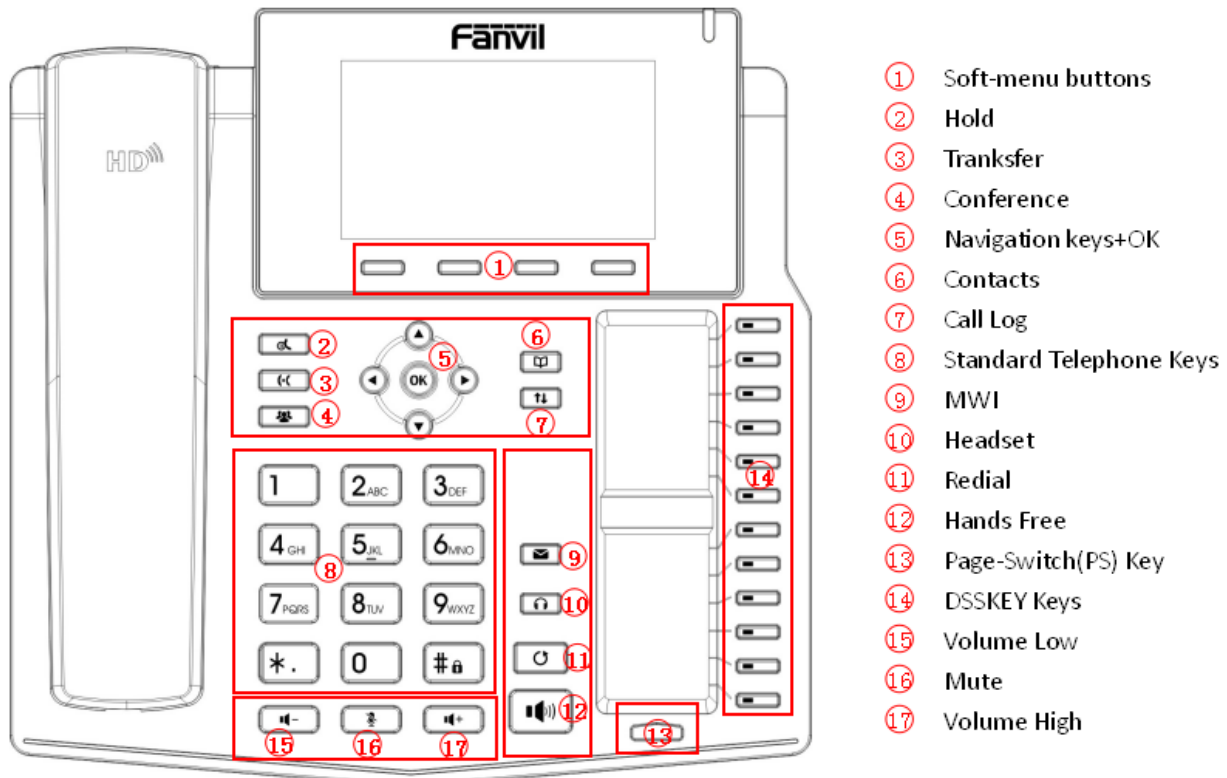

Figure 5 - Keypad

The above picture shows the keypad layout of the device. Each key provides its own specific function. User should refer to the illustration in this section about the usage of each key and the description in this document about each function.

Some keys support long-pressing function. User can press and hold the key for 1.5 seconds to trigger the long-pressed function.

- Soft-menu Buttons – These four buttons provide different functions corresponding to the soft-menu displayed on the screen.
- Standard Telephone Keys – The 12 standard telephone keys provide the same function as



standard telephones, but further to the standard function, some keys also provide special function by long-pressing the key,

- Key # - Long-pressed to lock the phone. (Default PIN is 1234)
- Navigation Keys – User can press up/down navigator keys to change line focus in talking screen or move cursor in a screen with list items; in some configuration or text editor screen, user can press left/right navigator keys to switch option or move cursor to the left / right.
- Hold – Press "hold" button during the call, the user can hold the call, press again to cancel the call to maintain, return to normal call state.
- Transfer – Press the "Transfer" button, the user can transfer the current call to other numbers.
- Conference – Press the "Conference" button, the user can initiate a three-party conference.
- Redial – By pressing 'Redial' button, user can redial the last dialed number.
- Hands-free Speaker – By pressing this button once, user can turn on the audio channel of hands-free speaker
- Pn / Page-Jump – By pressing this button with a number which ranges from 1 - 5, user can switch specific DSS LCD page.
- Volume Low – In standby, ringing, ring configuration screen, user can press this button to lower the ringtone volume; in talking and audio volume adjustment screen, user can press this button to lower the audio volume.
- Microphone Mute – User can mute the microphone with this button during talking mode.
- Volume High – In standby, ringing, ring configuration screen, user can press this button to increase the ringtone volume; in talking and audio volume adjustment screen, user can press this button to increase the audio volume.

4.2 Using Handset / Hands-free Speaker / Headphone

■ Using Handset

To talk over handset, user should lift the handset off the device and dial the number, or dial the number first, then lift the handset and the number will be dialed. User can switch audio channel to handset by lifting the handset when audio channel is opened in speaker or headphone.

■ Using Hands-free Speaker

To talk over hands-free speaker, user should press the hands-free button then dial the number, or dial the number first then press the hands-free button. User can switch audio channel to the speaker from handset by pressing the hands-free button when audio channel is opened in handset.



■ Using Headphone

To use headphone, by default, user should headset button which is defined by DSS key to turn on the headphone. Same as handset and hands-free speaker, user can dial the number before or after headphone turned on.

■ Using Line Keys(Defined by DSS Key)

User can use line key to make or answer a call on specific line. If handset has been lifted, the audio channel will be opened in handset, otherwise, the audio channel will be opened in hands-free speaker or headphone.

4.3 Screen User Interface



Figure 6 - Screen Layout / Default Standby Screen

The screen user interface is mostly presented in the above layout except some prompt messages. The upper area is the main screen to display the device's status and information or data for viewing or editing. The lower area is the software menu (soft-menu) buttons which will change against user's action or device's status.

The above picture shows the default standby screen which is also the root of the soft-menu. The default standby screen shows the greeting words and effective feature indications like voice



message, missed call, auto-answering, do-not-disturb, call forward, lock state, and the network connectivity. User can get back to the default standby screen mostly by lifting and putting by the handset.

The icon illustration is described in **Appendix I - Icon Illustration**.

In some screens, there are more items or long text to be displayed which could not fit into the screen. They will be arranged in a list or multiple lines with a scroll bar. If user sees a scroll bar, user can use up/down navigator buttons to scroll the list. By long-pressed the navigator keys, user can scroll the list or items in a faster speed.

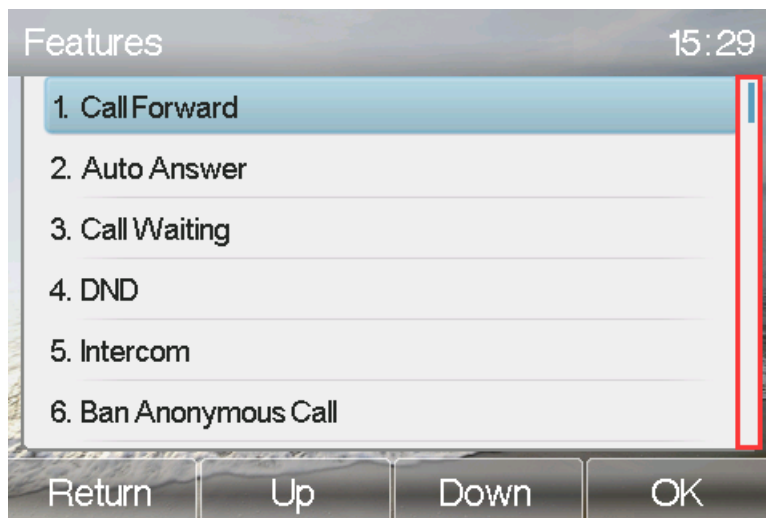

Figure 7 - Vertical Scroll Bar

4.4 Web Portal

User can also use the device's web portal to manage or operate the device. User should open the device's web portal page by entering the device's IP address in a browser. To get the device IP address, user could press the soft-menu button [Menus] -> [Status] or by pressing [Down] navigator key.





The screenshot shows a web-based network configuration interface. At the top, there are four tabs: '网络' (Network), '设备' (Device), '帐户' (Account), and '网管登录' (Network Management Login). The '网络' tab is selected and highlighted in yellow. Below the tabs is a table with two columns: 'ID' and 'Value'. The table contains six rows of configuration data. The first row is highlighted in light blue. At the bottom of the interface, there is a '返回' (Return) button.

ID	Value
1. 模式	DHCP
2. IP地址	172.16.2.123
3. 掩码	255.255.0.0
4. 网关	172.16.1.1
5. 主域名	8.8.8.8
6. 次域名	202.96.134.133

返回

Figure 8 - Check the Device's IP Address



The first screen of the device's web portal is the login page.

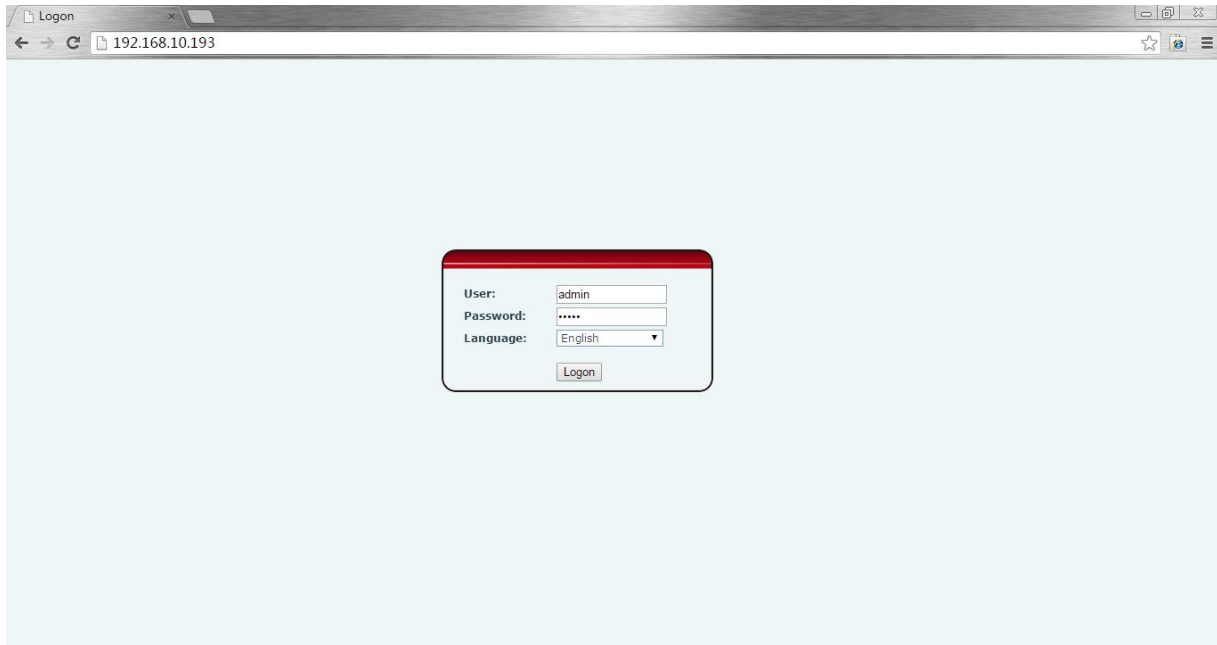

Figure 9 - Web Portal Login Page

User must enter the username and password to log in to the web portal. **The default username and password are both 'admin'**. For the detail of web portal operations, please refer to **8 Web Portal**.



5 Setting Up

In order to get the device ready for making and receiving phone calls, the device must be configured with correct network configurations and at least one of the lines must be configured with an IP telephony service.

5.1 Network Configuration

The device relies on IP network connection to provide service. Unlike traditional phone system based on a circuit switched wire technology, IP devices are connected to each other over the network and exchange data in packet basis based on the devices' IP address.

To enable the device, the network parameters must be configured properly first. To configure network parameters, user should open the network configuration screen through soft-menu [Menu] -> [Advanced] -> [Network] -> [Network] from standby screen.

NOTICE! If user saw a  'WAN Disconnected' icon flashing in the middle of screen, it means the network cable was not correctly connected to the device's network port. Please check the cable is connected correctly to the device and to the network switch, router, or modem.

There are three common IP configuration modes.

- Dynamic Host Configuration Protocol (DHCP) – This is the automatic configuration mode by getting network configurations from a DHCP server. Users need not to configure any parameters manually. All configuration parameters will be getting from DHCP server and applied to the device. This is recommended for most users.
- Static IP Configuration – This option allows user to configure each IP parameters manually, including IP Address, Subnet Mask, Default Gateway, and DNS servers. This is usually used in an office environment or by power users.
- PPPoE – This option is often used by users who connect the device to a broadband modem or router. To establish a PPPoE connection, user should configure username and password provided by the service provider.



The device is default configured in DHCP mode.

5.2 Line Configurations

A line must be configured properly to be able to provide telephony service. The line configuration is like a virtualized SIM card. Just like a SIM card on a mobile phone, it stores the service provider and the account information used for registration and authentication. When the device is applied with the configuration, it will register the device to the service provider with the server's address and user's authentication as stored in the configurations.

To configure a line manually, user may open the line configuration screen through soft-menu button [Menu] ->[Advanced] -> [Accounts] -> [SIP1] / [SIP2] / [SIP3] / [SIP4] / [SIP5] / [SIP6] -> [Basic] from the standby screen.

NOTICE! User must enter correct PIN code to be able to advanced settings to edit line configuration. (The default PIN is 123)

The parameters and screens are listed in below pictures.

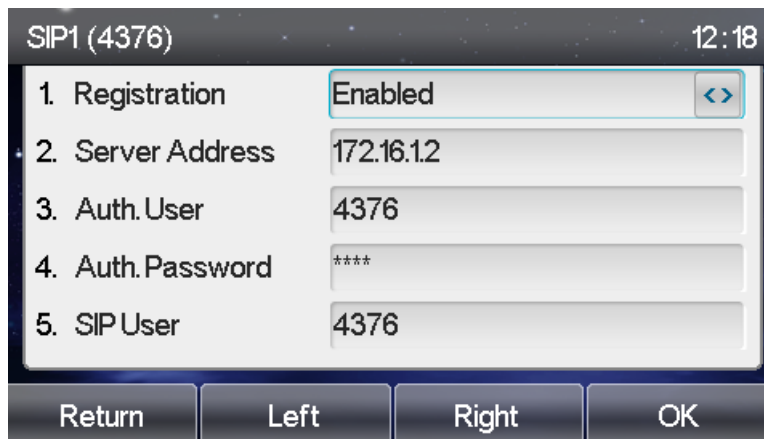

Figure 10 - SIP address and account information



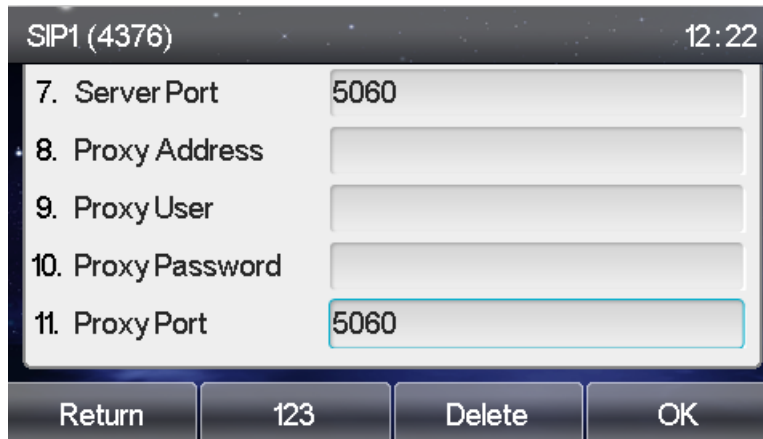

Figure 11 - Line proxy information

Save the adjustment by pressing [OK] when done.

For users who want to configure more options, user should use web management portal to modify or Advanced Settings in accounts on the individual line to configure those options.

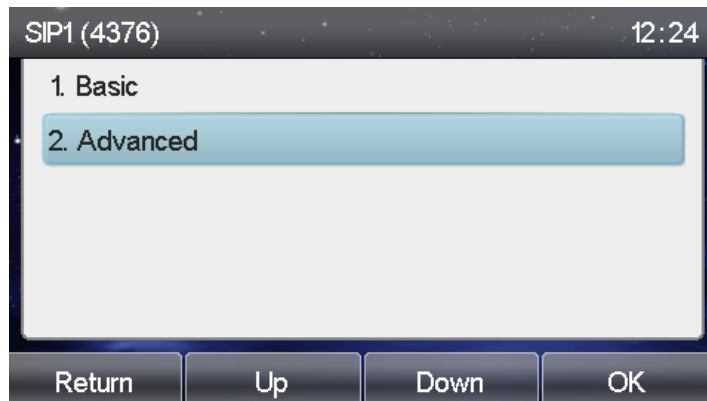

Figure 12 - Configure Advanced Line Options



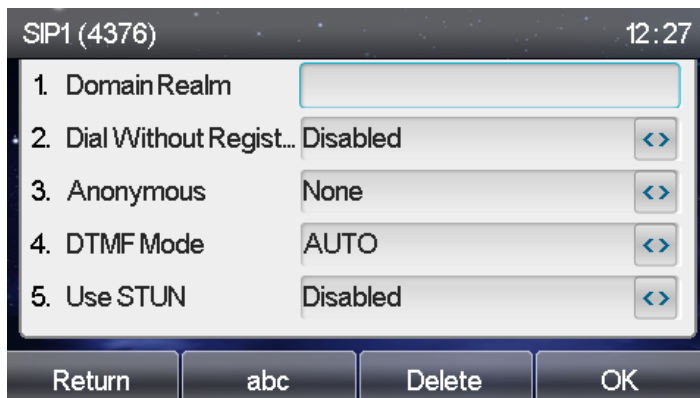

Figure 13 - Account Advanced Settings(1)

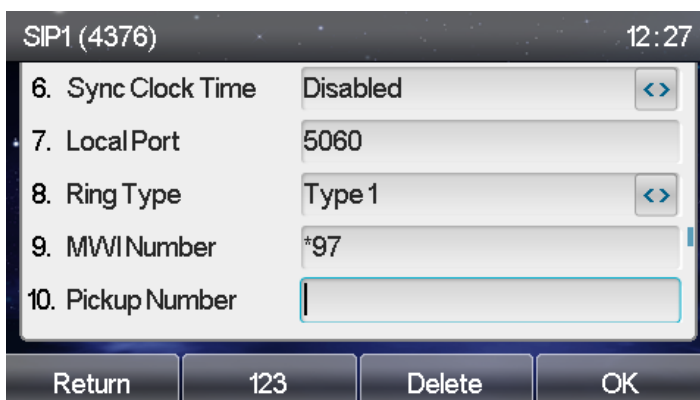

Figure 14 - Account Advanced Settings(2)

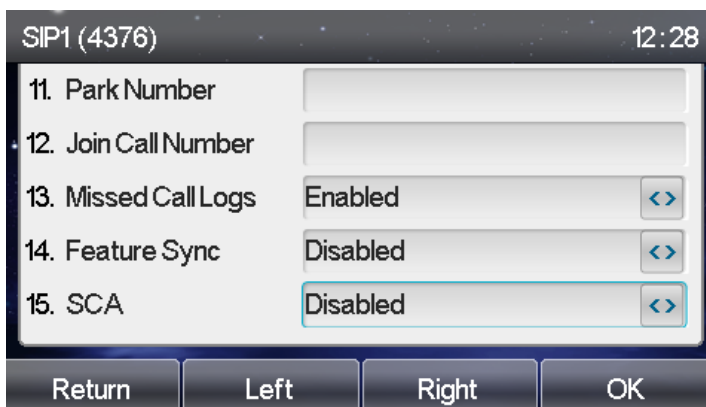

Figure 15 - Account Advanced Settings(3)



6 Using the Phone

6.1 Making Phone Calls

■ Default Line

The device provides six line services. If both lines are configured, user can make or receive phone calls on either line. If default line is configured by user, there will be a default line to be used for making outgoing call which is indicated on the top left corner. To change the default line, user can press left/right navigator buttons to switch between two lines. Enable or disable default line, user can press [menu] -> [Features] -> [General] -> [Default Line] or configure from Web Interface (Web / PHONE / Features / Basic Settings).



Figure 16 - Default Line

■ Dialing Methods

User can dial a number by,

- Entering the number directly
- Selecting a phone number from phonebook contacts (Refer to **6.2 Using Phonebook**)
- Selecting a phone number from cloud phonebook contacts (Refer to **6.3 Using Cloud Phonebook**)
- Selecting a phone number from call logs (Refer to **6.4 Call Logs**)
- Redialing the last dialed number

■ Dialing Number then Opening Audio

To make a phone call, user can firstly dial a number by one of the above methods. When the dialed number is completed, user can press [Dial] button on the soft-menu, or press hand-free button to



turn on the speaker or headphone, or lift the handset to call out with the current line, or user can press line key(Configured by DSS Keys) to call out with specified line.

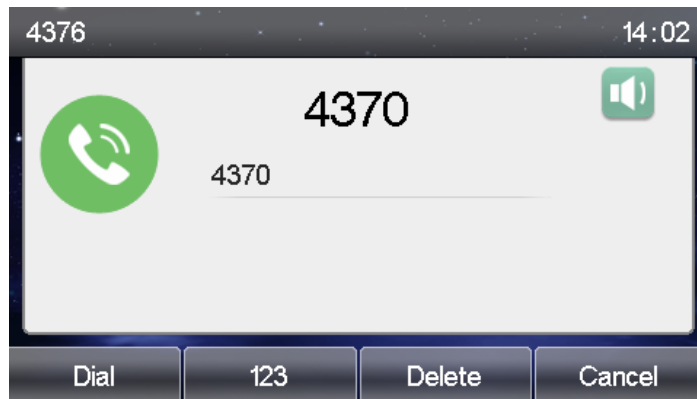

Figure 17 - Dialing a Number before Audio Channel Opened

■ Opening Audio then Dialing the Number

Another alternative is the traditional way to firstly open the audio channel by lifting the handset, turning on the hands-free speaker or headphone by pressing hands-free button, or line key, and then dial the number with one of the above methods. When number dialed completed, user can press [Dial] button or [OK] button to call out, or the number will be dialed out automatically after timeout.

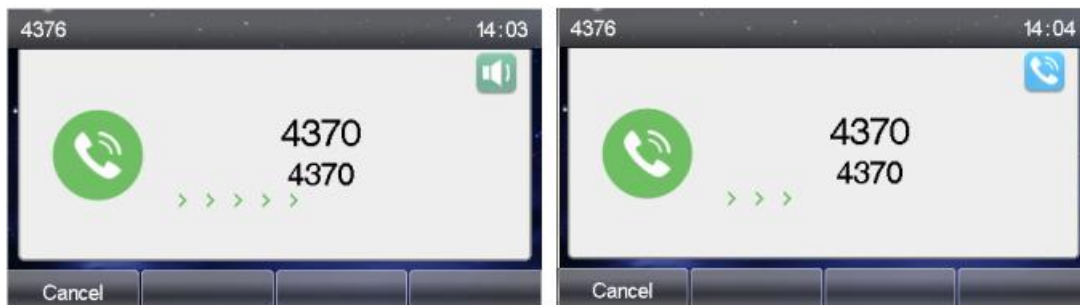

Figure 18 - Dial a Number after Audio Channel Opened

NOTICE! For some users who get used to dial a number immediately by pressing **#** key, the user must login to the web to enable 'Press "#" to invoke dialing' option in page [Line] -> [Dial Plan] -> "Basic Settings" and apply it.



■ Cancel Call

While calling the number, user can press [Cancel] button or close the audio channel by put back the handset or press the hands-free button to drop the call.

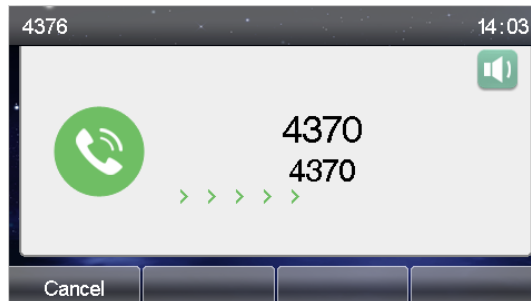

Figure 19 - Calling Remote Party

■ Answering Incoming Call

When there is an incoming call while the device is idle, user will see the following incoming call alerting screen

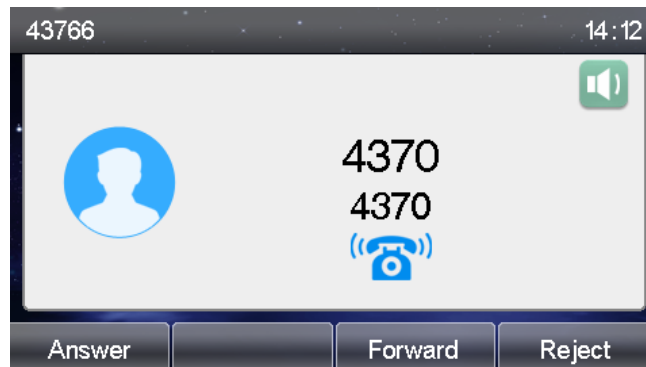

Figure 20 - Incoming Call Screen

User can answer the call by lifting the handset, open headphone or speaker phone by pressing the hands-free button, or the [OK] / [Answer] button. To divert the incoming call, user should press [Divert] button. To reject the incoming call, user should press [Reject] button.



■ Talking

When the call is connected, user will see a talking mode screen as the following figure

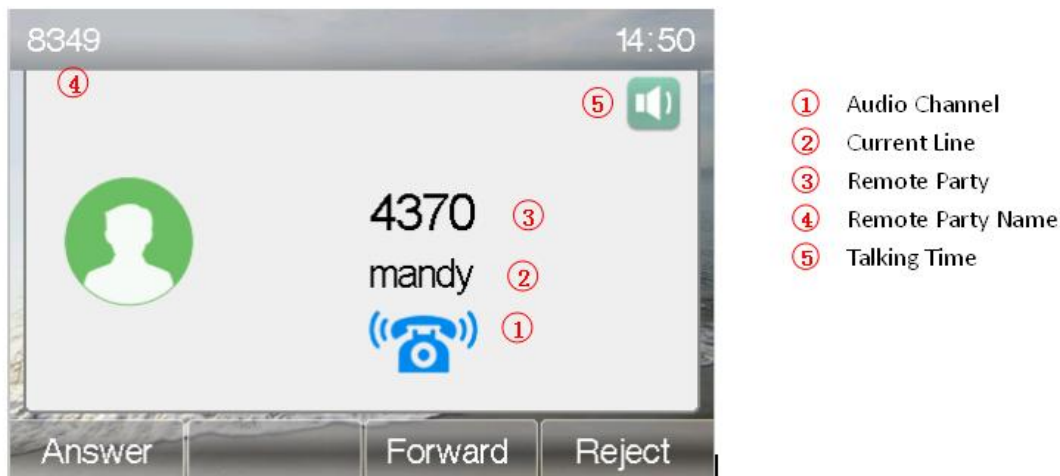

Figure 21 - Talking Mode Screen

Audio Channel – The icon reflects the current audio channel being used.

Current Line – The line is being used on the call.

Remote Party – The number of the remote party.

Remote Party Name– The name of the remote party.

Talking time – The time passed since the call established.

■ Call Holding /Resuming

User can hold the remote party by pressing [Hold] button and the button will be changed to [Resume] icon. User can press the [Resume] button to resume the call.

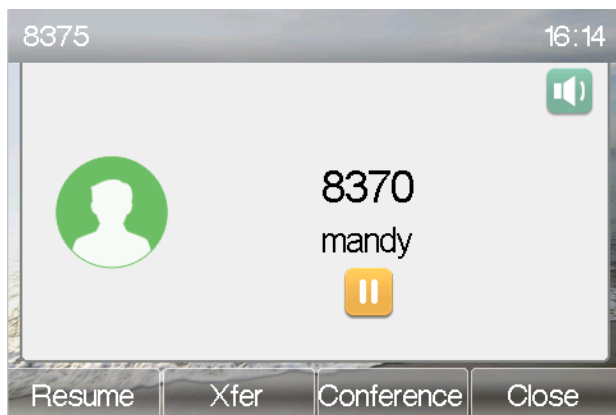

Figure 22 - Call Holding Screen



■ Call Ended

When user finished the call, user can put the handset back to the device to hang up the call or press the hands-free button to close the audio channel to hang up.

6.1.1 Make / Receive Second Call

The device can support up to two concurrent calls. When there is already a call established, user can still answer another incoming call on either lines or make a second call on either lines.

■ Second Incoming Call

When there is another incoming call during talking a phone call, this call will be waiting for user to answer it. User will see the call message in the middle of current screen. The device will not be ringing but playing call waiting tone in the audio channel of the current call and the LED will be flashing in green. User can accept or reject the call same as normal incoming call. When the waiting call is answered, the first call will be put on hold automatically.



Figure 40 – Second Incoming Call Screen

■ Second Outgoing Call

To make a second call, user may press [XFER] / [Conf] button to make a new call on the default line or press the line key to make new call on specific line. Then dial the number the same way as making a phone call. Another alternative for making second call is to pressing DSS Keys dial out from the configured Keys (BLF/Speed Dial). When user is making a second call with the above methods, the first call could be place on hold manually first or will be put on hold automatically at second dial.

■ Switching between Two Calls



When there are two calls established, user will see a dual calls screen as the following picture,

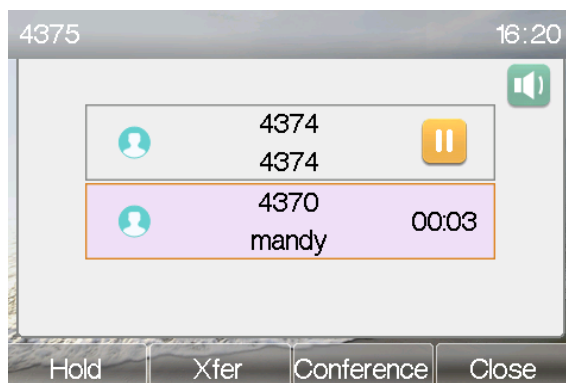

Figure 23 - Dual Calls

User can press up/down navigator buttons to switch screen page, and switch call focus by pressing [Hold] / [Resume] button.

■ Ending One Call

User may hang up the current talking call by closing the audio channel or press [Close] button. The device will return to single call mode in holding state.

6.1.2 Join / Split Two Calls (3-way Local Conference)

In the dual call mode, user can join two calls into a conference call by pressing [Conf] button. When two calls are joined, user can split them by pressing [Split] button.

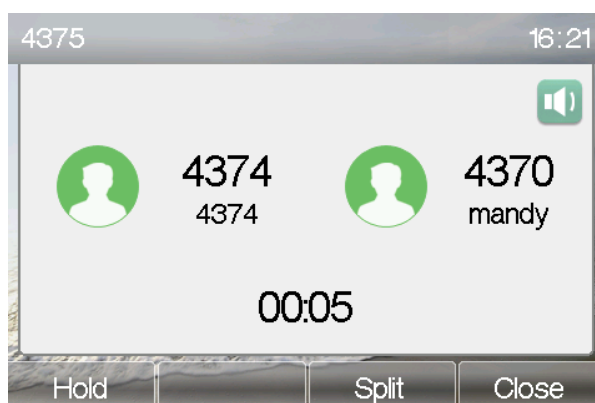

Figure 24 - Conference Call



6.1.3 Call Transfer

When the user is talking with a remote party and wish to transfer the call to another remote party, there are two way to transfer the call, attended and unattended.

■ Attended Transfer

The attended call transfer is also known as the 'polite mode' which is to dial through the other remote party, wait for the remote party to answer the call and then transfer the call.

This is the same procedure as making two concurrent calls. In the dual call mode, press the [Xfer] button to transfer the first party to the second one.

■ Unattended / Blind Transfer

Unattended transfer is also known as 'Fire and Forget' mode. Instead of connecting to the second party first and confirming the second call is established, user press [Xfer] button first then dial the second party number. When the number is dialed, user can press[Xfer] button again and the first party will be transfer to the second.

This is like helping the first party to dial to the second one. However, the transfer could be successful if the second party answered it, or could be failed if the second party is busy or rejected it.

NOTICE! More advanced transfer configuration, please refer to 错误! 未找到引用源。 错误!
未找到引用源。 .

6.2 Using Phonebook

User can save contacts' information in the phonebook and dial the contact's phone number(s) from the phonebook. To open the phonebook, user can press soft-menu button [Contact] in the default standby screen or keypad.

By default the phonebook is empty, user may add contact(s) into the phonebook manually or from call logs .



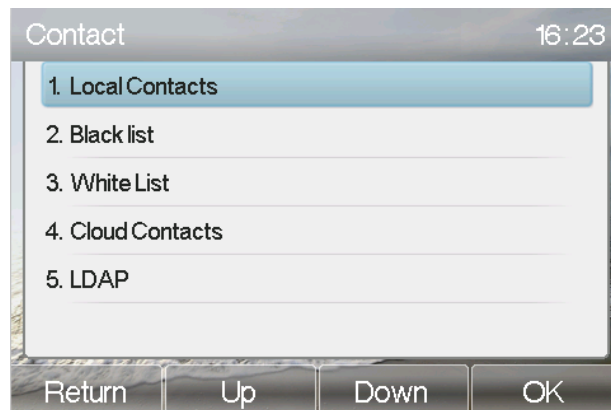

Figure 25 - Phonebook screen

NOTICE! The device can save up to total 1000 contact records.



Figure 26 - Local Phonebook

When there are contact records in the phonebook, the contact records will be arranged in the alphabet order. User may browse the contacts with up/down navigator keys. The record indicator tells user which contact is currently focused. User may check the contact's information by pressing [OK] button.

Figure 27 - Browsing Phonebook



6.2.1 Add / Edit / Delete Contact

To add a new contact, user should press [Add] button to open Add Contact screen and enter the contact information of the followings,

- Contact Name
- Tel. Number
- Mobile Number
- Other Number
- Line
- Ring Tone
- Contact Group
- Photo

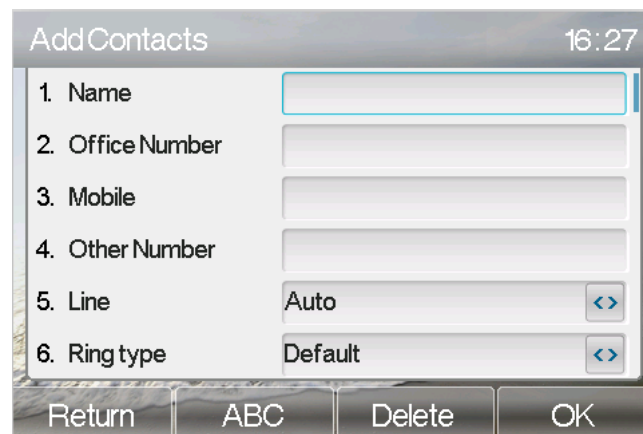

The screenshot shows a mobile application interface titled "Add Contacts" with a time of 16:27 in the top right corner. The screen contains six numbered input fields: 1. Name (with a text input box), 2. Office Number (with a text input box), 3. Mobile (with a text input box), 4. Other Number (with a text input box), 5. Line (with a dropdown menu showing "Auto" and a right arrow button), and 6. Ring type (with a dropdown menu showing "Default" and a right arrow button). At the bottom of the screen, there is a navigation bar with four buttons: "Return", "ABC", "Delete", and "OK".

Figure 28 - Add New Contact

User can edit a contact by pressing [Option] -> [Edit] button.

To delete a contact, user should move the record indicator to the position of the contact to be deleted, press [Option] -> [Delete] button and confirm with [OK].

6.2.2 Add / Edit / Delete Group

By default, the group list is blank. User can create his/her own groups, edit the group name, add or remove contacts in the group, and delete a group.

To add a group, press [AddGroup] button.

To delete a group, press [Option] -> [Delete] button.



To edit a group, press [Edit] button.

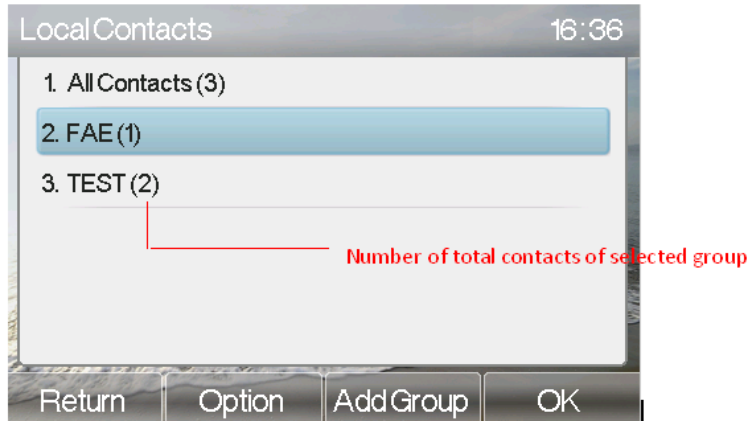

Figure 29 - Group List

6.2.3 Browse and Add / Remove Contacts in Group

User can browse contacts in a group by opening the group in group list with [OK] button.



Figure 30 - Browsing Contacts in a Group

When user is browsing contacts of a group, user can also add contacts in that group by pressing [Add] button to enter the group contacts management screen, then press [OK] button to save the contact, the contact will also be added in local phonebook. User can delete contact from group by [Option]->[Delete].



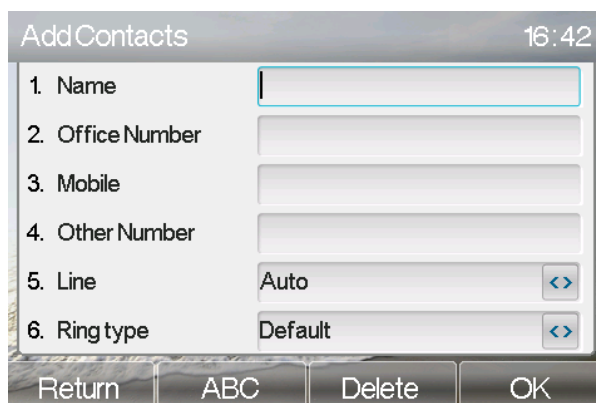

Figure 31 - Add Contacts in a Group

6.3 Using Cloud Phonebook

Cloud phonebook allows user to configure the device to download a phonebook from a cloud server. This is very useful for office users to use the phonebook from a single source and save the effort to create and maintain the contact list individually. It is also a useful tool for user to synchronize his/her phonebook from a personal mobile phone to the device with Fanvil Cloud Phonebook Service and App which is to be provided publicly soon.

NOTICE! The cloud phonebook is ONLY temporarily downloaded to the device each time it is opened on the device to ensure the user get the most up to date phonebook. However, the downloading may take a couple seconds depending on the network condition. Therefore, it is highly recommended to the users to save important contacts from cloud to local phonebook to save the time of waiting for downloading.

To open cloud phonebook list, press[Menu]->[PhoneBook]->[Cloud Contacts] in phonebook screen.



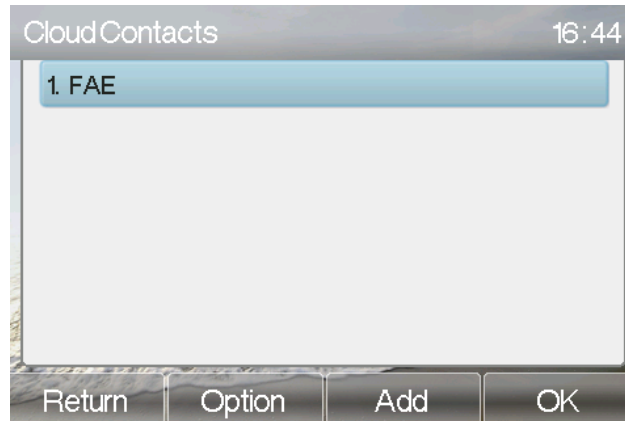

Figure 32 - Cloud Phonebook List

6.3.1 Open Cloud Phonebook

In cloud phonebook screen, user can open a cloud phonebook by pressing [OK] / [Enter] button. The device will start downloading the phonebook. If downloading failed, user will be prompted with a warning message.

Once the cloud phonebook is downloaded completed, user may browse the contact list and dial the contact number same as in local phonebook.

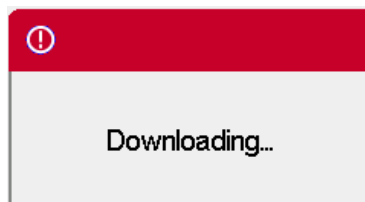

Figure 33 - Downloading Cloud Phonebook



Figure 34 - Browsing Contacts in Cloud Phonebook



6.4 Call Logs

The device can store up to 300 call log records and user can open the call logs to check all incoming, outgoing, and missed call records by pressing soft-menu button [CallLog] .

In the call logs screen, user may browse the call logs with up/down navigator keys.

Each call log record is presented with 'call type' and 'call party number / name'. User can check further call log detail by pressing [OK] button and dial the number with [Dial] button, or add the call log number to phonebook with pressing [Option] -> [Add to Contact] .

User can delete a call log by pressing [Delete] button and can clear all call logs by pressing [Delete All] button.

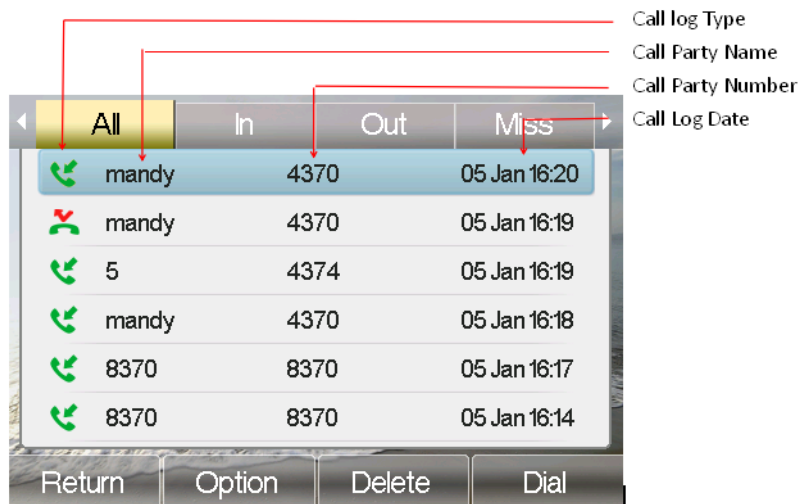

Figure 35 - Call Logs

User can also filter call logs with specific call log type to narrow down the call log records by pressing the left/right navigator button and select one of the call log types in the soft-menu buttons,



- Missed Calls



- Received Calls / Incoming Calls



 - Dialer Calls / Outgoing Calls



Filter	Call ID	Number	Date/Time
In	mandy	4370	05 Jan 16:20
	5	4374	05 Jan 16:19
	mandy	4370	05 Jan 16:18
	8370	8370	05 Jan 16:17
	8370	8370	05 Jan 16:14
	8370	8370	05 Jan 16:13
Out	mandy	4370	05 Jan 15:59
	589	589	05 Jan 15:58
	589	589	05 Jan 15:58
	mandy	4370	03 Jan 17:23
	5	4374	03 Jan 17:23
	mandy	4370	03 Jan 17:17
Miss	mandy	4370	05 Jan 16:19
	8370	8370	05 Jan 16:02
	8370	8370	05 Jan 16:02
	8370	8370	05 Jan 16:01
	mandy	4370	05 Jan 16:01
	mandy	4370	05 Jan 16:01

Figure 36 - Filter Call Log Type

6.5 Voice Message

If the service of the lines supports voice message feature, when the user is not available to answer the call, the caller can leave a voice message on the server to the user. User will receive voice message notification from the server and device will prompt a voice message waiting icon on the standby screen,



Figure 37 - New Voice Message Notification



Voice Mail Icon

To retrieve the voice messages, user must configure the voice message number first. Once the voice message number is configured, user can retrieve the voice message of a line by pressing the [Dial] button in the voice message screen.



When the device is in the default standby mode,

- Browser the DSS LCD items till you find the [MWI] button.
- Press [MWI] button to open voice message configuration screen, select the line to be configured with up/down navigator keys.
- Press [Edit] button to enable and edit the voice message number, when done, press [OK] button to save the configuration.

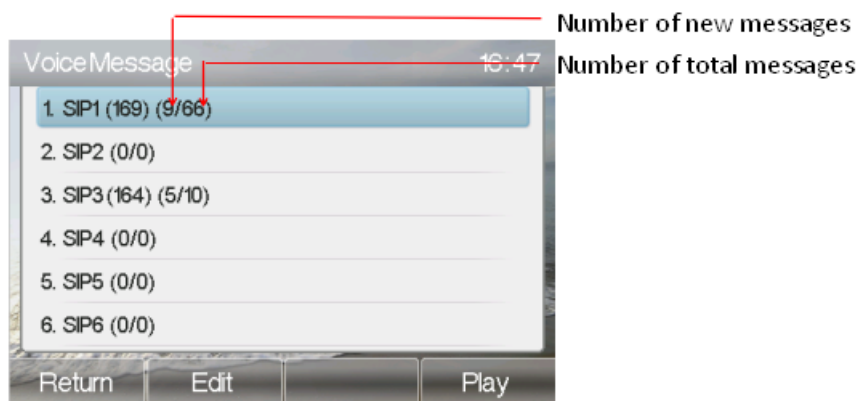

Figure 38 - Voice Message Screen

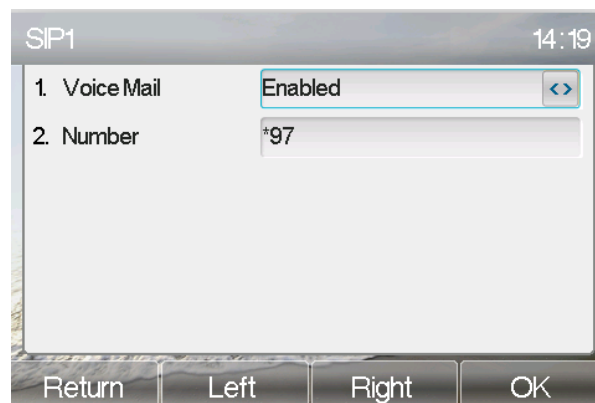

Figure 39 - Configure the Voice Message Number

6.6 Do-Not-Disturb

User may enable Do-Not-Disturb (DND) feature on the device to reject incoming calls (including call waiting). The DND can be enabled on line basis.



To quickly enable or disable the DND on all lines,

When the device is in the default standby mode,

- Press [DND] button to enter the DND setting interface, select line or phone to enable DND ,the

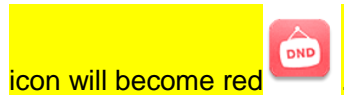

icon will become red .

- Press [DND] button to enter the DND setting interface and disable DND,the icon will be become



blue .



Figure 40 - DND Enabled

If user wishes to enable or disable DND on a specific line, user could change the DND mode in DND configurations.

- Press [DND] then you will enter into the edit page of [DND] .
- Press left/right navigator key to change the DND mode or DND state on specific line. When done, press [OK] button to save the changes.

- User will see icon become red  .



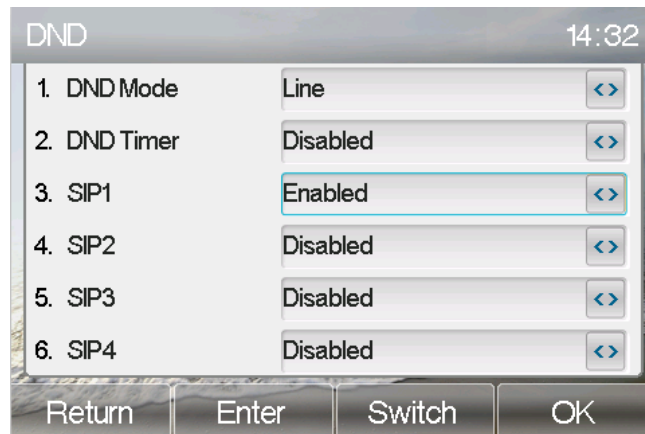

Figure 41 - Configure DND

The user can also use the DND timer. After the setting, the DND function will automatically turn on and the DND icon will turn red in the time range.

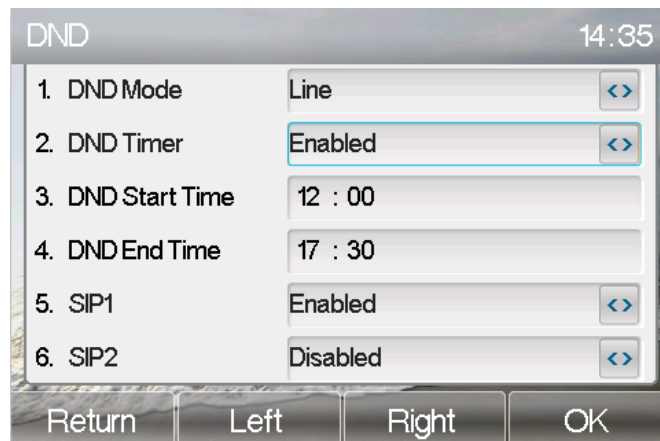



Figure 42 - DND Timer Settings

6.7 Auto-Answering

User may enable auto-answering feature on the device and any incoming call will be automatically answered (not including call waiting). The auto-answering can be enabled on line basis.

When the device is in the default standby mode, if user wishes to enable or disable auto-answering on a specific line or change the auto-answering delay time, user could change the auto-answering configuration adopt following steps.



- Press soft-button [Menu] till you find the [Features] item.
- Enter [Features] item till you find the [Auto Answer] item.
- Enter [Auto Answer] item to change the auto-answering configuration on a specific line
- Press left/right navigator button to select the auto-answering option. When done, press [OK] button to save the changes.
- The default auto-answering delay is 5 seconds.
- The Auto-answer icon  will appear in the upper right corner of the screen.

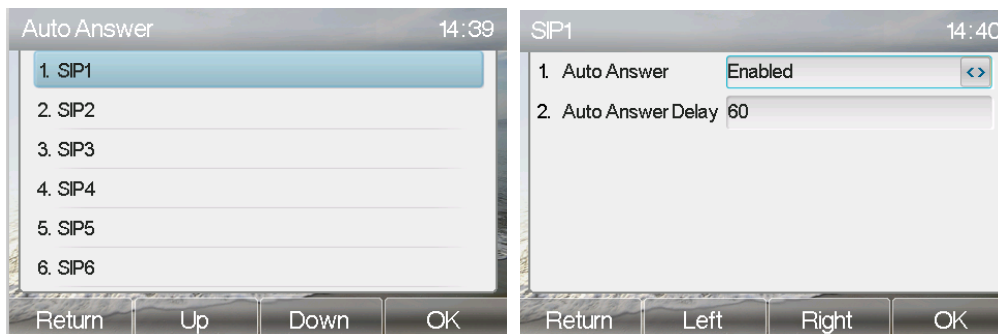

Figure 43 - Configure Auto-answering on Line1



Figure 44 - Auto-answering Enabled

6.8 Call Forward

Call forward is also known as 'Call Divert' which is to divert the incoming call to a specific number based on the conditions and configurations. User can configure the call forward settings of each line.

There are three types,

- **Unconditional Call Forward** – Forward any incoming call to the configured number.



- **Call Forward on Busy** – When user is busy, the incoming call will be forwarded to the configured number.
- **Call Forward on No Answer** – When user does not answer the incoming call after the configured delay time, the incoming call will be forwarded to the configured number.

To configure call forward, when the device is in the default standby mode,

- Press soft-button [Menu] till you find the [Features] item.
- Enter [Features] item till you find the [Call Forward] item.
- Press [Call Forward] button to open call forward configuration screen, select the line to be configured with up/down navigator keys.
- Press [Enter] button to edit the call forward settings.
- Select the call forward type with up/down navigator keys. Click [Enter] button to configure the call forward number and delay, if applicable.
- Enable or Disable call forward with left/right navigator buttons against specific lines and types.
- If select 'Enable', browse the setting parameters with up/down navigator keys and enter required information. When done, press [OK] button to save the changes.



Figure 45 - Select Line for Call Forward Configuration



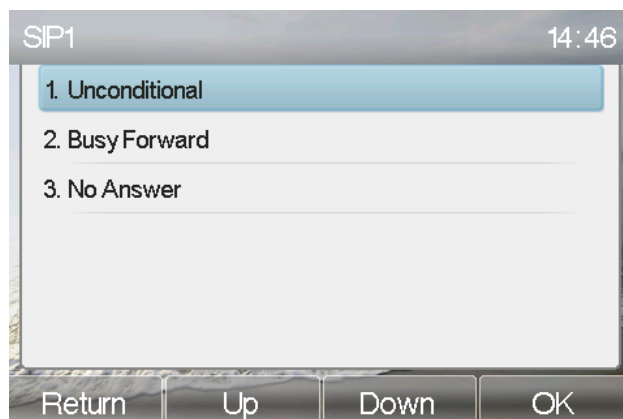

Figure 46 - Select Call Forward Type

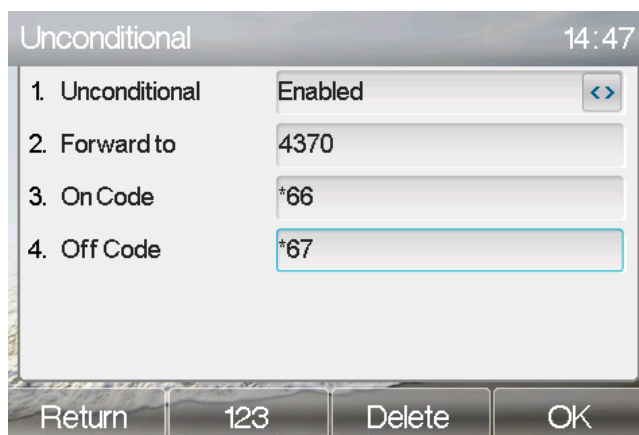

Figure 47 - Activate Call Forward and configure Call Forward Number

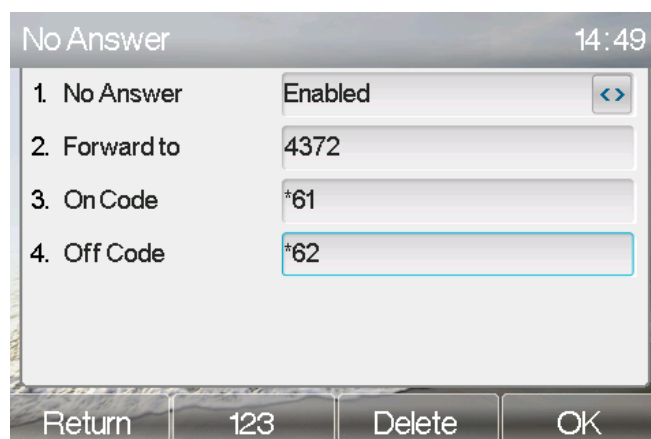

Figure 48 - Set Delay Time for Call Forward on No Answer



6.9 DSS LCD Configuration

There are 8 DSS keys corresponded to the LCD display to provide dynamic Line/DSS/BLF functions up to five pages at virtualized total 40 DSS keys. User may configure/customize each DSS key in each page.

User can enter the DSS Key page configuration in web DSSKEY page where user can Delete/Add page(s) for the DSS LCD. Besides, user can modify DSS key configuration by long-press each one.

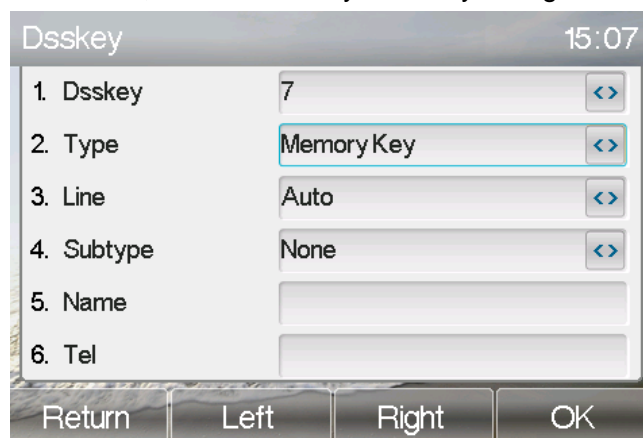

Figure 49 – DSS LCD Page Configuration Screen

The phone provide DSS Key configuration, such as,

- ◆ Memory Key
 - Speed Dial/Intercom/BLF/Presence/Call Park/Call Forward(For someone)
- ◆ Line
- ◆ Key Event
 - MWI/DND/Hold/Transfer/Phonebook/Redial/Pickup/Call Forward(for entitle line)/Headset/SMS/Release
- ◆ DTMF
- ◆ URL
- ◆ BLF List Key
- ◆ Multicast
- ◆ Application

Moreover, user also can add the user-defined title for the DSS Keys, which is configured as Memory Key / Line / URL / Multicast / Prefix / Disposition/ Escalate.

NOTICE! User-defined title is limited to 10 characters at most.



More detailed information refers to 9 错误! 未找到引用源。 and 错误! 未找到引用源。 .

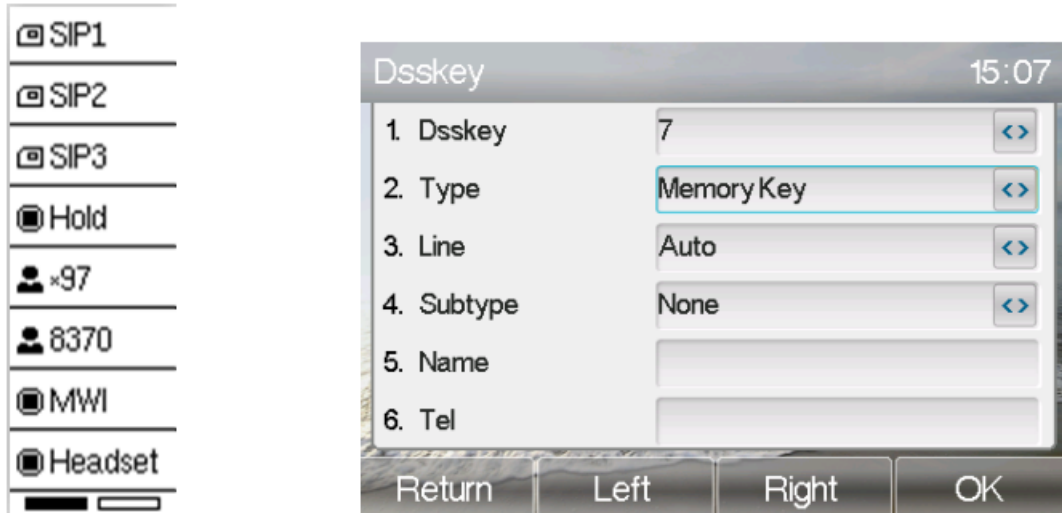

Figure 50 – DSS LCD Screen Configuration



7 Phone Settings

7.1 Adjust Audio Volume

When the device is in the default standby mode,

- Press soft-button [Menu] till you find the [Basic] item.
- Enter [Basic] item till you find [Voice Volume] item.
- Enter [Voice Volume] item and you will find [Handset] , [Handsfree] and [Headset] item.
- Enter [Handset] or [Handsfree] or [Headset] item, press Left / Right navigator keys to adjust the audio volume for different mode.
- Save the adjustment by pressing [OK] when done.

7.2 Set Ring Tone Volume and Type

When the device is in the default standby mode,

- Press soft-button [Menu] till you find the [Basic] item.
- Enter [Basic] item till you find [Ring] item.
- Enter [Ring] item and you will find [Headset] or [Handsfree] item, press left / right navigator keys to adjust the ring volume, Save the adjustment by pressing [OK] when done.
- Enter [Ring type] item, press left / right navigator keys to change the ring type, Save the adjustment by pressing [OK] when done.

7.3 Adjust LCD Contrast

When the device is in the default standby mode,

- Press soft-button [Menu] till you find the [Basic] item.
- Enter [Basic] item till you find [Screen] item.
- Enter [Screen] item till you find [Backlight] item, press left / right navigator keys to enable or disable the LCD contrast.
- press left / right navigator keys to adjust Backlight Luminance and Backlight Time.
- Save the adjustment by pressing [OK] when done.



7.4 Set Device Time/Date

When the device is in the default standby mode,

- Press soft-button [Menu] till you find the [Basic] item.
- Enter [Basic] item till you find [Time & Date] item.
- Enter [Time & Date] item, use up/down navigator keys to edit the time/date parameters and save the settings by pressing [OK] when done.

Table 1 - Time Settings Parameters

Parameters	Description
Mode	Auto/Manual Auto: Enable network time synchronization via SNTP protocol, default enabled. Manual: User can modify data manually.
SNTP Server	SNTP server address
Time zone	Select the time zone
Time format	Select time format from one of the followings: <ul style="list-style-type: none"> ■ 1 JAN, MON ■ 1 January, Monday ■ JAN 1, MON ■ January 1, Monday ■ MON, 1 JAN ■ Monday, 1 January ■ MON, JAN 1 ■ Monday, January 1 ■ DD-MM-YY ■ DD-MM-YYYY ■ MM-DD-YY ■ MM-DD-YYYY ■ YY-MM-DD ■ YYYY-MM-DD
Separator	Choose the separator between year and month and day
12-Hour Clock	Display the clock in 12-hour format
Daylight Saving Time	Enable or Disable the Daylight Saving Time



7.5 Set Device Language

When the device is in the default standby mode,

- Press soft-button [Menu] till you find the [Basic] item.
- Enter [Basic] item till you find [Language] item.
- User can change the language by using the navigation keys.

7.6 Bluetooth Headset

X6S supports bluetooth headset, compatible with CSR 4.0 chip Bluetooth headset, you need to use USB dongle.

- Press soft-button [Menu] till you find the [Basic] item.
- Enter [Basic] item till you find [Bluetooth] item.
- Press [Bluetooth] to enter the setup interface. If there is no Bluetooth USB dongle inserted or incompatible with the already inserted, "No Hci Device" will be displayed and return to the Basic interface.
- Select Bluetooth, and use the left and right keys to enable bluetooth. Select Paired Device. If No paired is displayed, press [Scan] key to scan, then select the scanned device to connect.



Figure 51 – Bluetooth Settings Screen

7.7 Reboot the Device

When the device is in the default standby mode,

- Press soft-button [Menu] till you find the [Basic] item.
- Enter [Basic] item till you find [Reboot System] item.
- Press [OK] button, a warning message "Reboot Now?" will be prompt to user.
- Press [OK] button to execute the reset command, or [cancel] to exit.



7.8 Reset to Factory Default

When the device is in the default standby mode,

- Press soft-button [Menu] till you find the [Advance] item.
- Enter [Advanced] item, then input the device PIN (Default PIN is 123) to enter the interface.
- Enter [Factory Reset] item, enable the item you want to clear.
- Press [OK] button to execute the reset command, or [Return] to exit.



8 Web Portal

8.1 Web Portal Authentication

User can log in onto the device web portal to manage the device or user's profile. User must provide correct username and password to be able to log in.

8.2 SYSTEM / Information

User can get the system information of the device in this page including,

- Model
- Hardware Version
- Software Version
- Uptime

And also summarization of network status,

- Network Mode
- MAC Address
- IP
- Subnet Mask
- Default Gateway

Besides, summarization of SIP account status,

- SIP User
- SIP account status (Registered / Unapplied / Trying / Timeout)

8.3 SYSTEM / Account

User may change his/her web authentication password in this page.

For users with Administrators privilege, the user can also manage user accounts by adding or deleting user account and assign privilege and password to new account.

There are two types of user privilege, Administrators and Users. If a user account is created as Users privilege, this account will have limited accessibility to the device and cannot change some device settings.



The user account can be used to operate the device or access the device web portal by login to the device or its web. User should log in to device web portal with his/her username and web password.

NOTICE! *The device is shipped with a default Administrators user account. The username and password for the default account is 'admin' which has been printed on the brand and model label at the bottom side of the device.*

8.4 SYSTEM / Configurations

Users with Administrators privilege can export or import the device configuration in this page and reset the device to factory default.

■ Clear Configuration

SIP-----Account related configuration

AUTOPROVISION-----Autoprovision related configuration

NET-----Network related configuration

MMI-----MMI module, including authentication of user information, web access protocol and so on

TR069-----TR069 configuration

DSSKEY-----DSSKEY configuration

■ Clear Tables

Select the local data table to be cleared, all selected by default.

■ Reset Phone

The phone data will be cleared, including configuration and database tables.

8.5 SYSTEM / Upgrade

The device supports online upgrade by periodically checking the software release version on the cloud server. Meanwhile, user can download the software and upgrade the device manually when there is trouble for the device to connect to the cloud server.

8.6 SYSTEM / Auto Provision

The Auto Provision settings help IT manager or service provider to easily deploy and manage the



devices in mass volume. For the detail of Auto Provision, please refer to this link <http://www.fanvil.com/images/user/2014050802.pdf>

8.7 SYSTEM / Tools

Tools provided in this page help users to identify issues at trouble shooting. Please refer to **10 Trouble Shooting** for more detail.

Besides, the device also provided the screenshot feature to user, including mail screen and sub-screen.

8.8 NETWORK / Basic

User can configure the network connection type and parameters in this page.

8.9 NETWORK / Service Port

This page provides a web page login protocol settings, protocol port settings and RTP port settings.

Service Port Settings ⓘ	
Web Server Type:	HTTP ▼
Web Logon Timeout:	15 (10~30)Minute
web auto login:	<input type="checkbox"/>
HTTP Port:	80
HTTPS Port:	443
RTP Port Range Start:	10000
RTP Port Quantity :	1000
	Apply

8.10 NETWORK / Advanced

Network-level settings are typically configured by IT administrators to improve the quality of the



phone service. For configuration, please read “X6 Admin Guide”.

8.11 NETWORK / VPN

User may configure a VPN connection in this page. Please refer to **9.1 VPN** for more detail.

8.12 LINES / SIP

The service of the line is configured in this page, choose the sip line to configured (SIP 1 – SIP 6). Click the dropdown arrow to adjust configuration accounting on each line.

Table 2 - Line Configuration on Web

Parameters	Description
Register Settings	
Line Status	Display the current line status at page loading. To get the up to date line status, user has to refresh the page manually.
Server Address	Enter the IP or FQDN address of the SIP server
Server Port	Enter the SIP server port, default is 5060
Authentication User	Enter the authentication user of the service account
Authentication Password	Enter the authentication password of the service account
Username	Enter the username of the service account.
Display Name	Enter the display name to be sent in a call request.
Activate	Whether the service of the line should be activated
Realm	Enter the SIP domain if requested by the service provider
SIP Proxy Server Address	Enter the IP or FQDN address of the SIP proxy server
Proxy Server Port	Enter the SIP proxy server port, default is 5060
Proxy User	Enter the SIP proxy user
Proxy Password	Enter the SIP proxy password



Backup Proxy Server Address	Enter the IP or FQDN address of the backup proxy server
Backup Proxy Server Port	Enter the backup proxy server port, default is 5060
Basic Settings	
Enable Auto Answering	Enable auto-answering, the incoming calls will be answered automatically after the delay time
Auto Answering Delay	Set the delay for incoming call before the system automatically answered it
Call Forward Unconditional	Enable unconditional call forward, all incoming calls will be forwarded to the number specified in the next field
Call Forward Number for Unconditional	Set the number of unconditional call forward
Call Forward on Busy	Enable call forward on busy, when the phone is busy, any incoming call will be forwarded to the number specified in the next field
Call Forward Number for Busy	Set the number of call forward on busy
Call Forward on No Answer	Enable call forward on no answer, when an incoming call is not answered within the configured delay time, the call will be forwarded to the number specified in the next field
Call Forward Number for No Answer	Set the number of call forward on no answer
Call Forward Delay for No Answer	Set the delay time of not answered call before being forwarded
Transfer Timeout	Set the timeout of call transfer process
Conference Type	Set the type of call conference, Local=set up call conference by the device itself, maximum supports two remote parties, Server=set up call conference by dialing to a conference room on the server
Server Conference Number	Set the conference room number when conference type is set to be Server
Subscribe For Voice Message	Enable the device to subscribe a voice message waiting notification, if enabled, the device will



	receive notification from the server if there is voice message waiting on the server
Voice Message Number	Set the number for retrieving voice message
Voice Message Subscribe Period	Set the interval of voice message notification subscription
Enable Hotline	Enable hotline configuration, the device will dial to the specific number immediately at audio channel opened by off-hook handset or turn on hands-free speaker or headphone
Hotline Delay	Set the delay for hotline before the system automatically dialed it
Hotline Number	Set the hotline dialing number
Dial Without Registered	Set call out by proxy without registration
Enable Missed Call Log	If enabled, the phone will save missed calls into the call history record.
DTMF Type	Set the DTMF type to be used for the line
DTMF SIP INFO Mode	Set the SIP INFO mode to send '*' and '#' or '10' and '11'
Enable DND	Enable Do-not-disturb, any incoming call to this line will be rejected automatically
Registration Expiration	Set the SIP expiration interval
Use VPN	Set the line to use VPN restrict route
Use STUN	Set the line to use STUN for NAT traversal
Codec Settings	Set the priority and availability of the codecs by adding or remove them from the list.
Advanced Settings	
Use Feature Code	When this setting is enabled, the features in this section will not be handled by the device itself but by the server instead. In order to control the enabling of the features, the device will send feature code to the server by dialing the number specified in each feature code field.
Enable DND	Set the feature code to dial to the server
Disable DND	Set the feature code to dial to the server



Enable Call Forward Unconditional	Set the feature code to dial to the server
Disable Call Forward Unconditional	Set the feature code to dial to the server
Enable Call Forward on Busy	Set the feature code to dial to the server
Disable Call Forward on Busy	Set the feature code to dial to the server
Enable Call Forward on No Answer	Set the feature code to dial to the server
Disable Call Forward on No Answer	Set the feature code to dial to the server
Enable Blocking Anonymous Call	Set the feature code to dial to the server
Disable Blocking Anonymous Call	Set the feature code to dial to the server
Call Waiting On Code	Set the feature code to dial to the server
Call Waiting Off Code	Set the feature code to dial to the server
Send Anonymous On Code	Set the feature code to dial to the server
Send Anonymous Off Code	Set the feature code to dial to the server
SIP Encryption	Enable SIP encryption such that SIP transmission will be encrypted
SIP Encryption Key	Set the pass phrase for SIP encryption
RTP Encryption	Enable RTP encryption such that RTP transmission will be encrypted
RTP Encryption Key	Set the pass phrase for RTP encryption
Enable Session Timer	Set the line to enable call ending by session timer refreshment. The call session will be ended if there is not new session timer event update received after the timeout period
Session Timeout	Set the session timer timeout period
Enable BLF List	Enable/Disable BLF List
BLF List Number	BLF List allows one BLF key to monitor the status of a group. Multiple BLF lists are supported.
Keep Alive Type	Set the line to use dummy UDP or SIP OPTION packet to keep NAT pinhole opened
Keep Alive Interval	Set the keep alive packet transmitting interval
Keep Authentication	Keep the authentication parameters from previous authentication
Blocking Anonymous Call	Reject any incoming call without presenting caller ID



User Agent	Set the user agent, the default is Model with Software Version.
Specific Server Type	Set the line to collaborate with specific server type
SIP Version	Set the SIP version
Anonymous Call Standard	Set the standard to be used for anonymous
Local Port	Set the local port
Ring Type	Set the ring tone type for the line
Enable user=phone	Sets user=phone in SIP messages.
Use Tel Call	Set use tel call
Auto TCP	Using TCP protocol to guarantee usability of transport for SIP messages above 1500 bytes
Transport Protocol	Set the line to use TCP or UDP for SIP transmission
Enable Rport	Set the line to add rport in SIP headers
Enable PRACK	Set the line to support PRACK SIP message
DNS Mode	Select DNS mode, A, SRV, NAPTR
Enable Long Contact	Allow more parameters in contact field per RFC 3840
Enable Strict Proxy	Enables the use of strict routing. When the phone receives packets from the server, it will use the source IP address, not the address in via field.
Convert URI	Convert not digit and alphabet characters to %hh hex code
Use Quote in Display Name	Whether to add quote in display name, i.e. "Fanvil" vs Fanvil
Enable GRUU	Support Globally Routable User-Agent URI (GRUU)
Sync Clock Time	Time Syncn with server
Caller ID Header	Set the Caller ID Header
Use 182 Response for Call waiting	Set the device to use 182 response code at call waiting response
Response Single Codec	If setting enabled, the device will use single codec in response to an incoming call request



BLF Server	The registered server will receive the subscription package from ordinary application of BLF phone. Please enter the BLF server, if the sever does not support subscription package, the registered server and subscription server will be separated.
Enable Feature Sync	Feature Syncn with server
Enable SCA	Enable/Disable SCA (Shared Call Appearance)
CallPark Number	Set the callPark number
Server Expire	
TLS Version	Choose TLS Version

8.13 LINES / Dial Plan

Register Settings

Register Settings

- Press # to invoke dialing
- Dial Fixed Length to Send
- Send after second(s)(3~30)
- Press # to Do Blind Transfer
- Blind Transfer on Onhook
- Attended Transfer on Onhook
- Attended Transfer on Conference Onhook
- Enable E.164

Figure 52 – Dial Plan

The device supports 7 dialing modes:

- Press # to Send - Dial the desired number, and press # to send it to the server.
- Dial Fixed Length – Configure the fixed length to dial out
- Send after seconds – Number will be sent to the server after the specified time.
- Press # to Do Blind Transfer - Press # after entering the target number for the transfer. The phone will transfer the current call to the third party.



- Blind Transfer on Onhook - Hang up after entering the target number for the transfer. The phone will transfer the current call to the third party.
- Attended Transfer on Onhook - Hang up after the third party answers. The phone will transfer the current call to the third party.
- Attended Transfer on Conference Onhook - Hang up during a 3-way conference call, the other two ways will make a call.
- Enable E.164 – You can refer to the E.164 standard.

Dial Plan Add:

Dial Plan Add

Digit Map:

Apply to Call: Match to Send:

Line: Destination: Port:

Alias(Optional): Phone Number: Length:

Suffix:

Dial Plan Option

User-defined Dial Plan Table

Digit Map	Call	Match to Send	Line	Alias Type: Number(length)	Suffix
-----------	------	---------------	------	----------------------------	--------

This functionality offers you more flexible dial rule, you can refer to the following content to know how to use this dial rule.

Parameters	Description
Digit Map	<p>There are two types of matching: Full Matching or Prefix Matching. In Full matching, the entire phone number is entered and then mapped per the Dial Peer rules.</p> <p>In prefix matching, only part of the number is entered followed by T. The mapping with then take place whenever these digits are dialed. Prefix mode supports a maximum of 30 digits.</p>



<p>Note: Two different special characters are used.</p> <ul style="list-style-type: none"> ■ x -- Matches any single digit that is dialed. ■ [] -- Specifies a range of numbers to be matched. It may be a range, a list of ranges separated by commas, or a list of digits. 	
Destination	Set Destination address. This is for IP direct.
Port	Set the Signal port, and the default is 5060 for SIP.
Alias	Set the Alias. This is the text to be added, replaced or deleted. It is an optional item.
<p>Note: There are four types of aliases.</p> <ul style="list-style-type: none"> ■ all: xxx - xxx will replace the phone number. ■ add: xxx - xxx will be dialed before any phone number. ■ del - The characters will be deleted from the phone number. ■ rep: xxx - xxx will be substituted for the specified characters. 	
Suffix	Characters to be added at the end of the phone number. It is an optional item.
Length	Set the number of characters to be deleted. For example, if this is set to 3, the phone will delete the first 3 digits of the phone number. It is an optional item.

This feature allows the user to create rules to make dialing easier. There are several different options for dial rules. The examples below will show how this can be used.

Example 1: Substitution -- Assume that it is desired to place a direct IP call to IP address 172.168.2.208. Using this feature, 123 can be substituted for 172.168.2.208.

Example 2: Substitution -- To dial a long distance call to Beijing requires dialing area code 010 before the local phone number. Using this feature 1 can be substituted for 010. For example, to call 62213123 would only require dialing 162213123 instead of 01062213123.

Example 3: Addition -- Two examples are shown. In the first case, it is assumed that 0 must be dialed before any 11 digit number beginning with 13. In the second case, it is assumed that 0 must be dialed before any 11 digit number beginning with 135, 136, 137, 138, or 139. Two different



special characters are used.

x -- Matches any single digit that is dialed.

[] -- Specifies a range of numbers to be matched. It may be a range, a list of ranges separated by commas, or a list of digits.

8.14 LINES / Register Settings

Register global settings for lines,

Table 3 - Global Settings for Lines on Web

Parameters	Description
STUN Settings	
Server Address	Set the STUN server address
Server Port	Set the STUN server port, default is 3478
Binding Period	Set the STUN binding period which can be used to keep the NAT pinhole opened.
SIP Waiting Time	Set the timeout of STUN binding before sending SIP messages
TLS Certification File	Upload or delete the TLS certification file used for encrypted SIP transmission.

8.15 PHONE / Features

Configure the phone features,

Common Settings

Table 4 - Common Phone Feature Settings on Web

Parameters	Description
Basic Settings	
Enable Call Waiting	Enable this setting to allow user to take second incoming call during an established call. Default enabled.
Enable Call Waiting Tone	Turn off this feature, and you will not hear a



	'beep' sound in talking mode when there is another incoming call
Semi-Attended Transfer	Enable Semi-Attended Transfer by selecting it
Enable 3-Way Conference	Enable 3-way conference by selecting it
Enable Auto Handdown	The phone will hang up and return to the idle automatically at hands-free mode
Auto Handdown Time	Specify Auto handdown time, the phone will hang up and return to the idle automatically after Auto Hand down time at hands-free mode, and play dial tone Auto handdown time at handset mode
Ring From Headset	Enable Ring From Handset by selecting it, the phone plays ring tone from handset.
Auto Headset	Enable this feature, headset plugged in the phone, user press 'answer' key or line key to answer a call with the headset automatically.
Enable Silent Mode	When enabled, the phone is muted, there is no ringing when calls, you can use the volume keys and mute key to unmute.
Disable Mute for Ring	When it is enabled,you can not mute the phone
Enable Default Line	If enabled, user can assign default SIP line for dialing out rather than SIP1.
Enable Auto Switch Line	Enable phone to select an available SIP line as default automatically
Default Ext Line	Select the default line to use for outgoing calls
Ban Outgoing	If you select Ban Outgoing to enable it, and you cannot dial out any number.
Hide DTMF	Configure the hide DTMF mode
Enable CallLog	Select whether to save the call log
Allow IP Call	If enabled, user can dial out with IP address
P2P IP Prefix	You can set IP call prefix,for example,i set it as "172.16.2.",then i input #160 in dialpad and press dial key ,it will call 172.16.2.160 automatically



Caller Name Priority	Change caller ID display priority. The default priority is “Phonebook” > “LDAP”>“SIP Display Name”. User may select one of the options to change the desired caller ID display priority.
Search path	Select the search path.
LDAP Search	Select from with one LDAP for search
Emergency Call Number	Configure the Emergency Call Number. Despite the keyboard is locked, you can dial the emergency call number
Restrict Active URI Source IP	Set the device to accept Active URI command from specific IP address. More details please refer to this link http://www.fanvil.com/images/user/2014050801.pdf
Push XML Server	Configure the Push XML Server, when phone receives request, it will determine whether to display corresponding content on the phone which sent by the specified server or not.
Enable Pre-Dial	Disable this feature, user enter number will open audio channel automatically. Enable the feature, user enter the number without opening audio channel.
Tone Settings	
Enable Holding Tone	When turned on, a tone plays when the call is held
Enable Call Waiting Tone	When turned on, a tone plays when call waiting
Play Dialing DTMF Tone	Play DTMF tone on the device when user pressed a phone digits at dialing, default enabled.
Play Talking DTMF Tone	Play DTMF tone on the device when user pressed a phone digits during taking, default enabled.
DND Settings	
DND Option	Select to take effect on the line or on the phone



	or close
Enable DND Timer	Enable DND Timer, If enabled, the DND is automatically turned on from the start time to the off time
DND Start Time	Set DND Start Time
DND End Time	Set DND End Time
Intercom Settings	
Enable Intercom	When intercom is enabled, the device will accept the incoming call request with a SIP header of Alert-Info instruction to automatically answer the call after specific delay.
Enable Intercom Mute	Enable mute mode during the intercom call
Enable Intercom Tone	If the incoming call is intercom call, the phone plays the intercom tone
Enable Intercom Barge	Enable Intercom Barge by selecting it, the phone auto answers the intercom call during a call. If the current call is intercom call, the phone will reject the second intercom call
Response Code Settings	
DND Response Code	Set the SIP response code on call rejection on DND
Busy Response Code	Set the SIP response code on line busy
Reject Response Code	Set the SIP response code on call rejection
Password Dial Settings	
Enable Password Dial	Enable Password Dial by selecting it, When number entered is beginning with the password prefix, the following N numbers after the password prefix will be hidden as *, N stand for the value which you enter in the Password Length field. For example: you set the password prefix is 3, enter the Password Length is 2, then you enter the number 34567, it will display 3**67 on the phone.
Encryption Number Length	Configure the Encryption Number length



Password Dial Prefix	Configure the prefix of the password call number
----------------------	--

8.16 PHONE / Audio

Change the audio settings,

Table 5 - Audio Settings on Web

Parameters	Description
Codecs Settings	Select the enabled and disabled voice codecs codec:G.711A/U,G.722,G.723,G.729,G.726-32, ILBC,AMR,AMR-WB
Audio Settings	
Default Ring Type	Set the default ring type. If the caller ID of an incoming call was not configured with specific ring type, the default ring will be used.
Handset Volume	Set the Handset volume, the value must be 1~9
Speakerphone Volume	Set the speakerphone volume, the value must be 1~9
Headset Ring Volume	Set the ring volume in the headset, the value must be 1~9
Headset Volume	Set the Headset volume, the value must be 1~9
Speakerphone Ring Volume	Set the ring volume in the speakerphone, the value must be 1~9
G.723.1 Bit Rate	5.3kb/s or 6.3kb/s is available
DTMF Payload Type	Enter the DTMF payload type, the value must be 96~127.
AMR Payload Type	Set the AMR Payload Type
Headset Mic Offset	This is to adjust the base volume of the headset Mic.
ILBC Payload Type	Set the ILBC Payload Type
ILBC Payload Length	Set the ILBC Payload Length
Enable VAD	Enable Voice Activity Detection. When enabled, the device will suppress the audio transmission with artificial comfort noise signal to save the



	bandwidth.
Enable MWI Tone	The phone will play MWI tone when a new MWI Comes
Onhook Time	Configure the least reflection time of Hand down, the default is 200ms.
RTP Control Protocol(RTCP) Settings	
CNAME user	Set the CNAME user
CNAME host	Set the CNAME host
Alert Info Ring Settings	Set your Ring Type

8.17 PHONE / MCAST

This feature allows user to make some kind of broadcast call to people who are in multicast group. User can configure a multicast DSS Key on the phone, which allows user to send a Real Time Transport Protocol (RTP) stream to the pre-configured multicast address(es) without involving SIP signaling. You can also configure the phone to receive an RTP stream from pre-configured multicast listening address(es) without involving SIP signaling. You can specify up to 10 multicast listening addresses.

Table 6 - MCAST Parameters on Web

Parameters	Description
Normal Call Priority	Define the priority of the active call, 1 is the highest priority, 10 is the lowest.
Enable Page Priority	The voice call in progress shall take precedence over all incoming paging calls.
Name	Listened multicast server name
Host:port	Listened multicast server's multicast IP address and port.

8.18 PHONE / Action Url

About action url, please refer to <http://www.fanvil.com/images/user/2014050801.pdf>



8.19 PHONE / Time/Date

User can configure the device time settings in this page.

Table 7 - Time/Date Setting Parameters on Web

Parameters	Description
Network Time Server Settings	
Time Synchronized via SNTP	Enable time-sync through SNTP protocol
Time Synchronized via DHCP	Enable time-sync through DHCP protocol
Primary Time Server	Set primary time server address
Secondary Time Server	Set secondary time server address, when primary server is not reachable, the device will try to connect to secondary time server to get time synchronization.
Timezone	Select the time zone
Resync Period	Time of re-synchronization with time server
12-Hour Clock	Set the time display in 12-hour mode
Date Format	Select the time/date display format
Daylight Saving Time Settings	
Local	Choose your local phone will set daylight saving time automatically based on the local
DST Set Type	Choose DST Set Type, if Manual, you need to set the start time and end time.
Fixed Type	Daylight saving time rules are based on specific dates or relative rule dates for conversion. Display in read-only mode in automatic mode.
Offset	The offset minutes when DST started
Month Start	The DST start month
Week Start	The DST start week
Weekday Start	The DST start weekday
Hour Start	The DST start hour
Minute Start	The DST start minute
Month End	The DST end month
Week End	The DST end week



Weekday End	The DST end weekday
Hour End	The DST end hour
Minute End	The DST end minute
Manual Time Settings	You can set your time manually

8.20 PHONE / Advanced

User can configure the advanced configuration settings in this page.

- Screen Configuration.
 - Enable Energy Saving
 - Backlight Time
- LCD Menu Password Settings.

The password is 123 by default.

- Keyboard Lock Settings.
- Configure Greeting Words

The greeting message will display on the top left corner of the LCD when the device is idle, which is limited to 16 characters. The default chars are 'VOIP PHONE'.

8.21 PHONEBOOK / Contacts

User can add, delete, or edit contacts in the phonebook in this page. User can browse the phonebook and sorting it by name, phones, or filter them out by group.

To add a new contact, user should enter contact's information and press "Add" button to add it.

To edit a contact, click on the checkbox in front of the contact, the contact information will be copied to the contact edit boxes, press "Modify" button after finished editing.

To delete one or multiple contacts, check on the checkbox in front of the contacts wished to be deleted and click the "Delete" button, or click the "Clear" button with selecting any contacts to clear the phonebook.

User can also add multiple contacts into a group by selecting the group in the dropdown options in front of "Add to Group" button at the bottom of the contact list, selecting contacts with checkbox and click "Add to Group" to add selected contacts into the group.

Similarly, user can select multiple users and add them into blacklist by click "Add to Blacklist" button.



8.22 PHONEBOOK / Cloud Phonebook

Cloud Phonebook

User may configure up to 4 cloud phonebooks. Each cloud phonebook must be configured with an URL where an XML phonebook is stored. The URL may be based on HTTP/HTTPS or FTP protocol with or without authentication. If authentication is required, user must configure the username and password.

To configure a cloud phonebook, the following information should be entered,

- Phonebook name (must)
- Phonebook URL (must)
- Access username (optional)
- Access password (optional)

NOTICE! In regard of creating a cloud phonebook and setting up a cloud phonebook server, please refer to this link <http://www.fanvil.com/images/user/2014050810.pdf>

LDAP Settings

The cloud phonebook allows user to retrieve contact list from a LDAP Server through LDAP protocols.

User must configure the LDAP Server information and Search Base to be able to use it on the device. If the LDAP server requests an authentication, user should also provide username and password.

To configure a LDAP phonebook, the following information should be entered,

- Display Title (must)
- LDAP Server Address (must)
- LDAP Server Port (must)
- Search Base (must)
- Access username (optional)
- Access password (optional)

NOTICE! In regard of creating a LDAP phonebook and setting up a LDAP phonebook server, please refer to <http://www.fanvil.com/images/user/2014050808.pdf>.



8.23 PHONEBOOK / Blacklist

■ Restricted Incoming Calls

It same as blacklist.By adding a number into the blacklist, user will no longer receive phone call from that number and it will be rejected automatically by the device until user delete it from the blacklist.

User can add specific number to be blocked, or a prefix where any numbers matched the prefix will all be blocked.

■ Allowed Incoming Calls

When DND is enabled, the allow incoming calls can still come in.

■ Restrict Outgoing Call

You can set the rule to restrict some numbers from dialing out,until you remove the number from the table.

8.24 PHONEBOOK / Advanced

User may export current phonebook in xml, csv, or vcf format file and save it locally on a computer.

User can also import contacts into phonebook from an xml, csv, or vcf file.

NOTICE! If user repeatedly imports a same phonebook, the same contact will be ignored .If same name but the number is different, a contact will be created again.

User can add new group in this page or delete an existing one. Deleting a contact group will not delete the contacts in that group.

8.25 CALL LOGS

User can browse complete call logs in this page, order the call logs by time, caller ID, contact name, duration, or line, and can also filter the call logs by the call log types, in, out, missed, or all.

User can save a call log into his/her phonebook or add it to the blacklist or whitelist.



User can also make web call by click on the number of a call log.

8.26 FUNCTION KEY / Function Key

The device provides 40 user-define DSS Keys at most. User may configure/customize each DSS key in this webpage.

Table 8 – DSS Key Setting Parameters on Web

Parameters	Description
Memory Key	<p>BLF(NEW CALL/BXFE /AXFER): It is used to prompt user the state of the subscribe extension, and it can also pick up the subscribed number, which help user monitor the state of subscribe extension (idle, ringing, a call). There are 3 types for one-touch BLF transfer method. p.s. User should enter the pick-up number for tspecific BLF key to fulfill the pick-up operation.</p> <p>Presence: Compared to BLF, the Presence is also able to view whether the user is online. Note: You cannot subscribe the same number for BLF and Presence at the same time</p> <p>Speed Dial: You can call the number directly which you set. This feature is convenient for you to dial the number which you frequently dialed.</p> <p>Intercom: This feature allows the operator or the secretary to connect the phone quickly; it is widely used in office environments.</p>
Line	It can be configured as a Line Key. User is able to make a call by pressing Line Key.
Key Event	<p>User can select a key event as a shortcut to trigger.</p> <p>For example: MWI / DND / Release / Headset / Hold / etc.</p>
DTMF	It allows user to dial or edit dial number easily.
URL	Open the specific URL directly.



Multicast	Configure the multicast address and audio codec. User presses the key to initiate the multicast.
-----------	--

8.27 FUNCTION KEY / Advanced

User can set Dsskey transfer mode and Memory Key action.

- Dsskey Transfer Mode

For example i have setted a memory value is 4370,when the phone talking with other number for example 4374,when press dsskey-4370,it will device to make a new call to 4370 or transer 4374 to 4370.

- Select MemoryKey Action

For example i have setted a memory value is 4370,when the phone talking with 4370,press this key to hold the call or hang up.

Global Key Settings

Dsskey Transfer Mode: Select MemoryKey Action:

8.28 Security / Security

Set whether to enable the Permission Certificateand Common Name Verification, select the Vertificate module.

You can upload and delete uploaded certificates.

8.29 Device Log/ Device Log

You can crawl the device log, when you encounter unusual problems, please send the device log to the technical staff for positioning problem.



9 Advanced Features

9.1 VPN

Virtual Private Network (VPN) is a technology to allow device to create a tunneling connection to a server and becomes part of the server's network. The network transmission of the device may be routed through the VPN server.

For some users, especially enterprise users, a VPN connection might be required to be established before activate a line registration. The device supports two VPN modes, Layer 2 Transportation Protocol (L2TP) and OpenVPN.

The VPN connection must be configured and started (or stopped) from the device web portal.

9.1.1 L2TP

NOTICE! The device only supports non-encrypted basic authentication and non-encrypted data tunneling. For users who need data encryption, please use OpenVPN instead.

To establish a L2TP connection, users should log in to the device web portal, open page [Network] -> [VPN]. In VPN Mode, check the "Enable VPN" option and select "L2TP", then fill in the L2TP server address, Authentication Username, and Authentication Password in the L2TP section. Press "Apply" then the device will try to connect to the L2TP server.

When the VPN connection established, the VPN IP Address should be displayed in the VPN status. There may be some delay of the connection establishment. User may need to refresh the page to update the status.

Once the VPN is configured, the device will try to connect to the VPN automatically when the device boots up every time until user disable it. Sometimes, if the VPN connection does not established immediately, user may try to reboot the device and check if VPN connection established after reboot.



9.1.2 OpenVPN

To establish an OpenVPN connection, user should get the following authentication and configuration files from the OpenVPN hosting provider and name them as the following,

OpenVPN Configuration file:	client.ovpn
CA Root Certification:	ca.crt
Client Certification:	client.crt
Client Key:	client.key

User then upload these files to the device in the web page [Network] -> [VPN], Section OpenVPN Files. Then user should check “Enable VPN” and select “OpenVPN” in VPN Mode and click “Apply” to enable OpenVPN connection.

Same as L2TP connection, the connection will be established every time when system rebooted until user disable it manually.



10 Trouble Shooting

When the device does not work properly, users may try the following methods to recover the device or gather relative information and send an issue report to Fanvil support.

10.1 Get Device System Information

Users may get the device system information by pressing [Settings] -> [Status]. The following basic information will be provided:

- Mode
- IP
- Software Version
- More...

User can select [More] item to get more information in detail.

10.2 Reboot Device

Users may reboot the device from soft-menu, [Menu] -> [Basic]->[Reboot System], and confirm the action by [OK]. Or, simply remove the power supply and restore it again.

10.3 Reset Device to Factory Default

Reset Device to Factory Default will erase all user's configuration, preference, database and profiles on the device and restore the device back to the state as factory default.

To perform a factory default reset, user should [Menu] -> [Advanced] -> , and then input the password to enter the interface. Then choose [Factory Reset] and press [Enter], and confirm the action by [OK]. The device will be rebooted into a clean factory default state.





10.4 Network Packets Capture

Sometimes it is helpful to dump the network packets of the device for issue identification. To get the packets dump of the device, user needs to log in the device web portal, open page [System] -> [Tools] and click [Start] in “Network Packets Capture” section. A pop-up message will be prompt to ask user to save the capture file. User then should perform relevant operations such as activate/deactivate line or making phone calls and click [Stop] button in the web page when operation finished. The network packets of the device during the period have been dumped to the saved file. User may examine the packets with a packet analyzer or send it to Fanvil support.

10.5 Common Trouble Cases

Table 9 - Trouble Cases

Trouble Case	Solution
Device could not boot up	<ol style="list-style-type: none"> 1. The device is powered by external power supply via power adapter or PoE switch. Please use standard power adapter provided by Fanvil or PoE switch met with the specification requirements and check if device is well connected to power source. 2. If you saw “POST MODE” on the device screen, the device system image has been damaged. Please refer to the instructions in “错误！未找到引用源。 错误！未找到引用源。” to restore the system image.
Device could not register to a service provider	<ol style="list-style-type: none"> 1. Please check if device is well connected to the network. The network Ethernet cable should be connected to the  [Network] port NOT the  [PC] port. If the cable is not well connected to the network icon  [WAN disconnected] will be flashing in the middle of the screen. 2. Please check if the device has an IP address. Check the system information, if the IP displays “Negotiating...”, the device does not have an IP address. Please check if the network configurations is correct. 3. If network connection is fine, please check again your line configurations. If all configurations are correct, please kindly contact your service provider to get support, or follow the



	<p>instructions in “10.6 Network Packet Capture” to get the network packet capture of registration process and send it to Fanvil support to analyze the issue.</p>
No Audio or Poor Audio in Handset	<ol style="list-style-type: none"> 1. Please check if Handset is connected to the correct Handset (📶) port NOT Headphone (🎧) port. 2. The network bandwidth and delay may be not suitable for audio call at the moment.
Poor Audio or Low Volume in Headphone	<ol style="list-style-type: none"> 1. There are two Headphone wire sequence in the market. Please use the Headphone provided by Fanvil, or consult Fanvil the wire sequence if you wish to use a third party headphone. 2. The network bandwidth and delay may be not suitable for audio call at the moment.
Audio is chopping at far-end in Hands-free speaker mode	<p>This is usually due to loud volume feedback from speaker to microphone. Please lower down the speaker volume a little bit, the chopping will be gone.</p>



Appendix I - Icon Illustration

Table 10 - Keypad Icons

























	Phonebook
	Redial
	Call logs
	Handsfree (HF) speaker
	Phone lock=Long-pressed Key(#)
	Mute Microphone (During Call)
	Volume Down
	Volume Up

Table 11 - Status Prompt and Notification Icons

	Call out
	Call in
	Call Hold
	Network Disconnected
	Keypad Locked
	Missed calls
	SMS
	New voice message waiting
	Do-Not-Disturb activated on Phone
	Do-Not-Disturb inactivated on Phone





























	Auto-answering activated
	Call forward activated
	Handsfree (HF) Mode
	Headphone (HP) Mode
	Handset (HS) Mode
	Microphone Muted



Appendix II – Text Input from Keypad

Table 12 - Look-up Table of Characters

Mode Icon	Text Mode	Key Button	Characters Of Each Press
	Numeric		1
			2
			3
			4
			5
			6
			7
			8
			9
			0
			*#(space)@,./?<>[]%! &\$~+-
			#
	Lower Case Alphabets		+ - * % / @ ! :
			a b c
			d e f
			g h i
			j k l
			m n o
			p q r s
			t u v
			w x y z
			0
			*#(space)@,./?<>[]%! &\$~+-
			#



ABC	Upper Case Alphabets	1	+ - * % / @ ! :
		2	A B C
		3	D E F
		4	G H I
		5	J K L
		6	M N O
		7	P Q R S
		8	T U V
		9	W Z Y X
		0	(space)
		*	*#(space)@,./?<>[]%! &\$~+-
		#	#
2aB	Mixed type input	1	1 + - * % / @ ! :
		2	2 a b c A B C
		3	3 d e f D E F
		4	4 g h I G H I
		5	5 j k I J K L
		6	6 m n o M N O
		7	7 p q r s P Q R S
		8	8 t u v T U V
		9	9 w z y x W Z Y X
		0	(space)
		*	*#(space)@,./?<>[]%! &\$~+-
		#	#



Appendix III – LED Definition

Table 13 - DSS KEY LED State

Type	LED Light	State
Line Key	Off	Line inactive
	Green On	Line ready (Registered)
	Green Blinking	Dialing / Ringing
	Yellow Blinking	Line is trying to register
	Red Blinking	Line error (Registration failure)
	Red On	Line in use (Talking)
	Yellow On	Call holding
BLF	Green On	Subscribed number is idle.
	Red On	Subscribed number is busy.
	Red Blinking	Subscribed number is dialing.
	Off	Subscribed number is unavailable
DND	Red On	Enable DND
	Off	Disable DND
MWI	Green On	New voice message waiting
	Off	No new voice message

Table 14 - ENB LED State

LED Light	State
Off	No event activated in other page of the DSS LCD
Green Blinking	Event activated in other page of the DSS LCD Such as: MWI / Incoming call
Yellow Blinking	Line is trying to register / The call is held or in holding state.
Red Blinking	Line error (Registration failure)

(*ENB: Event Notification Button)

